

TCR6

Standard RTD temperature sensor

TCR6-####-##0#-####-####-####

Overview

- Housing DIN form B
- Immersion depth to 3000 mm
- 4 ... 20 mA or HART output
- Pt100 class A/B, Pt1000-configurable

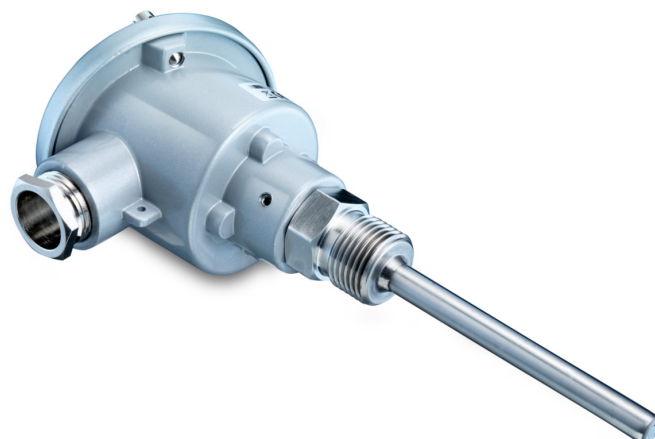

Picture similar



EN 50155

Technical data

Performance characteristics

Pt100 accuracy class (EN 60751)	B ($\pm 0.3\text{ °C at }0\text{ °C}$) $\pm (0.3 + 0.005 \times t)\text{ °C}$ A ($\pm 0.15\text{ °C at }0\text{ °C}$) $\pm (0.15 + 0.002 \times t)\text{ °C}$ 1/3 B ($\pm 0.1\text{ °C at }0\text{ °C}$) $\pm 1/3 \times (0.3 + 0.005 \times t)\text{ °C}$ 1/6 B ($\pm 0.05\text{ °C at }0\text{ °C}$) $\pm 1/6 \times (0.3 + 0.005 \times t)\text{ °C}$
---------------------------------	---

Pt1000 accuracy class (EN 60751)	B ($\pm 0.3\text{ °C at }0\text{ °C}$) $\pm (0.3 + 0.005 \times t)\text{ °C}$ 1/3 B ($\pm 0.1\text{ °C at }0\text{ °C}$) $\pm 1/3 \times (0.3 + 0.005 \times t)\text{ °C}$
----------------------------------	---

Max. flow velocity	40 m/s , gases 5 m/s , liquids
--------------------	-----------------------------------

Thermal response time, T50	$\leq 1.5\text{ s}$, $\varnothing 4\text{ mm}$ $\leq 6.1\text{ s}$, $\varnothing 6\text{ mm}$ $\leq 7.6\text{ s}$, $\varnothing 8\text{ mm}$ $\leq 13.6\text{ s}$, $\varnothing 8\text{ mm}$ with insert $\leq 11.1\text{ s}$, $\varnothing 10\text{ mm}$ $\leq 28.1\text{ s}$, $\varnothing 10\text{ mm}$ with insert
----------------------------	---

Process pressure	Refer to section "Operating conditions"
------------------	---

Process temperature	Refer to section "Operating conditions"
---------------------	---

Process connection

Connection variants	Refer to section "Dimensional drawings"
---------------------	---

Sensor length	20 ... 3000 mm
---------------	----------------

Sensor diameter outside	$\varnothing 6\text{ mm}$ $\varnothing 8\text{ mm}$ $\varnothing 10\text{ mm}$
-------------------------	--

Mounting position	Any, top, bottom, side
-------------------	------------------------

Standard response tip	$\varnothing 6\text{ mm}$ $\varnothing 8\text{ mm}$ $\varnothing 10\text{ mm}$
-----------------------	--

Fast response tip	$\varnothing 4\text{ mm}$
-------------------	---------------------------

Process connection

Sensor tube material	AISI 316L (1.4404)
----------------------	--------------------

Surface roughness wetted parts	$Ra \leq 0.8\text{ }\mu\text{m}$
--------------------------------	----------------------------------

Ambient conditions

Operating temperature range	-40 ... 160 °C , with Pt100 -40 ... 85 °C , with transmitter
-----------------------------	---

Storage temperature range	-40 ... 85 °C
---------------------------	---------------

Degree of protection (EN 60529)	IP 65
---------------------------------	-------

Humidity	$\leq 100\text{ \% RH}$, condensing
----------	--------------------------------------

Vibration (sinusoidal) (EN 60068-2-6)	1.6 mm p-p (2 ... 25 Hz), 4 g (25 ... 100 Hz), 1 octave / min.
---------------------------------------	--

Output signal

Without transmitter	1 x Pt100, 2-wire 1 x Pt100, 4-wire 2 x Pt100, 2-wire 1 x Pt1000, 2-wire
---------------------	---

With transmitter	4 ... 20 mA , 2-wire 4 ... 20 mA , 2-wire + HART®
------------------	--

Housing

Style	DIN form B
-------	------------

Overall size	Refer to section "Dimensional drawings"
--------------	---

Material	Aluminium
----------	-----------

Electrical connection

Connector	M12-A, 4-pin, nickel plated brass
-----------	-----------------------------------

Cable gland	M16x1.5, nickel plated brass M20x1.5, nickel plated brass
-------------	--

ATEX II 1 G Ex ia IIC T6...T5

Maximum values for barrier selection, Ui	28 V DC , with FlexTop 2202 30 V DC , with FlexTop 2212 30 V DC , with FlexTop 2222
--	---

TCR6

Standard RTD temperature sensor

TCR6 #####.#0#.####.####.####

Technical data

ATEX II 1 G Ex ia IIC T6...T5

Maximum values for barrier selection, Ii	0.1 A , with FlexTop 2202 0.095 A , with FlexTop 2212 0.095 A , with FlexTop 2222
Maximum values for barrier selection, Pi	0.7 W , with FlexTop 2202 0.75 W , with FlexTop 2212 0.75 W , with FlexTop 2222
Internal capacitance, Ci	10 nF , with FlexTop 2202 11 nF , with FlexTop 2212 11 nF , with FlexTop 2222
Internal inductance, Li	10 µH , with FlexTop 2202 24 µH , with FlexTop 2212 24 µH , with FlexTop 2222
Temperature class, T1 ... T4	-40 < Tamb < 80 °C , with FlexTop 2212 -40 < Tamb < 80 °C , with FlexTop 2222
Temperature class, T5	-40 < Tamb < 71 °C , with FlexTop 2212 -40 < Tamb < 71 °C , with FlexTop 2222

ATEX II 1 G Ex ia IIC T6...T5

Temperature class, T1 ... T5	-40 < Tamb < 85 °C , with FlexTop 2202
Temperature class, T6	-40 < Tamb < 50 °C , with FlexTop 2202 -40 < Tamb < 56 °C , with FlexTop 2212 -40 < Tamb < 56 °C , with FlexTop 2222

ATEX II 3 G Ex ec IIC T5

Voltage supply range, Un	30 V DC
Current rating, In	≤ 0.1 A
Temperature class, T1 ... T5	-40 < Tamb < 80 °C

Compliance and approvals

EMC	EN 61326-1
Railway applications	EN 50155
Explosion protection	ATEX II 1 G Ex ia IIC T6...T4 IECEX Ex ia IIC T6...T4 ATEX II 3 G Ex ec IIC T5 Ex ia Simple apparatus, gas and dust

TCR6

Standard RTD temperature sensor

TCR6-####-##0#-####-####-####

Transmitter

FlexTop 2202

Input	Pt100
Input Accuracy	$\leq \pm 0.25 \text{ }^\circ\text{C}$
Min. measuring span	25 $^\circ\text{C}$
Output	4 ... 20 mA , 2-wire
Output Accuracy	$\leq \pm 0.1 \%$, measuring span $\leq \pm 0.016 \text{ mA}$
Power supply	8 ... 35 V DC
Programmability	With FlexProgrammer 9701
Please note	For further information please see data sheet for FlexTop 2202

FlexTop 2212

Input	Pt100 Pt1000
Input Accuracy	$\leq \pm 0.06 \text{ }^\circ\text{C}$
Min. measuring span	10 $^\circ\text{C}$
Output	4 ... 20 mA , 2-wire 20 ... 4 mA , programmable
Output Accuracy	$\leq \pm 0.025 \%$, measuring span $\leq \pm 0.004 \text{ mA}$
Power supply	7 ... 40 V DC
Programmability	With FlexProgram
Please note	For further information please see data sheet for FlexTop 2212

FlexTop 2222

Input	Pt100 Pt1000
Input Accuracy	$\leq \pm 0.06 \text{ }^\circ\text{C}$
Min. measuring span	10 $^\circ\text{C}$
Output	4 ... 20 mA , 2-wire + HART® 20 ... 4 mA , programmable
Output Accuracy	$\leq \pm 0.025 \%$, measuring span $\leq \pm 0.004 \text{ mA}$
Power supply	7 ... 40 mA
Programmability	With FlexProgram With HART® modem
Please note	For further information please see data sheet for FlexTop 2222

Factory settings FlexTop 2202

Output range	0 ... 120 $^\circ\text{C}$
Damping	0 s
Output at sensor fault	23 mA

Factory settings FlexTop 2212

Output range	0 ... 100 $^\circ\text{C}$
Damping	0 s
Output at sensor fault	23 mA

Factory settings FlexTop 2222

Output range	0 ... 100 $^\circ\text{C}$
Damping	0 s
Output at sensor fault	23 mA

TCR6

Standard RTD temperature sensor

TCR6-####.#0#.####.####.####

Operating conditions

Ordering key	Process connection	BCID	Process pressure (bar)	Process temperature Standard @ Tamb ≤ 45 °C (° C)	Continuous	Process temperature
					Process temperature With cooling neck 71 mm @ Tamb ≤ 70 °C (° C)	Process temperature With cooling neck 142 mm / 213 mm @ Tamb ≤ 70 °C (° C)
TCR6-####.#10.####.####	Sleeve Ø 6	T65	-1 ... 40	-50 ... 400	-50 ... 400	-50 ... 600
TCR6-####.#12.####.####	G 1/2 A DIN 3852-A	G44	-1 ... 100	-50 ... 400	-50 ... 400	-50 ... 600
TCR6-####.#13.####.####	R 1/2 ISO 7-1	R06	-1 ... 100	-50 ... 400	-50 ... 400	-50 ... 600
TCR6-####.#16.####.####	M18 x 1.5 ISO 261 / ISO 965	M07	-1 ... 100	-50 ... 400	-50 ... 400	-50 ... 600
TCR6-####.#17.####.####	M20 x 1.5 ISO 261 / ISO 965	M08	-1 ... 100	-50 ... 400	-50 ... 400	-50 ... 600
TCR6-####.#18.####.####	1/2-14 NPT	N02	-1 ... 100	-50 ... 400	-50 ... 400	-50 ... 600
TCR6-####.#23.####.####	G 1/2 A ISO 228-1 female thread	G23	-1 ... 100	-50 ... 400	-50 ... 400	-50 ... 600
TCR6-####.#24.####.####	G 3/4 A ISO 228-1 female thread	G24	-1 ... 100	-50 ... 400	-50 ... 400	-50 ... 600
TCR6-####.#33.####.####	Rotating male nipple G 1/2 A ISO 228-1	G06	-1 ... 100	-50 ... 400	-50 ... 400	-50 ... 600
TCR6-####.#35.####.####	Rotating male nipple G 3/4 A ISO 228-1	G10	-1 ... 100	-50 ... 400	-50 ... 400	-50 ... 600
TCR6-####.#36.####.####	Rotating male nipple G 1 A ISO 228-1	G11	-1 ... 100	-50 ... 400	-50 ... 400	-50 ... 600

A process temperature up to 600 °C is only possible with Pt100 element code 'C'.

Dimensional drawings (mm)

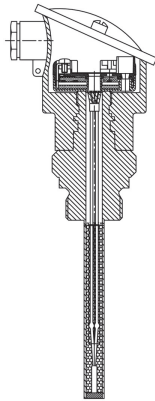

With embedded sensor

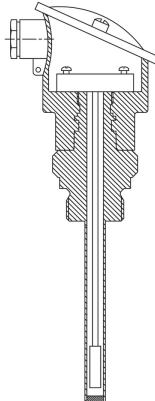

With cable sensor insert

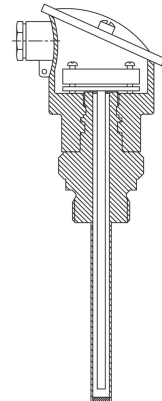

With DIN 43762 insert

TCR6

Standard RTD temperature sensor

TCR6-####-##0#-####-####-####

Dimensional drawings (mm)

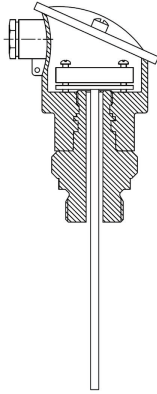

With insert DIN 43762, no immersion tube

Housing

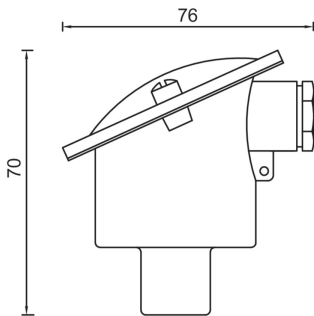

DIN Form B housing

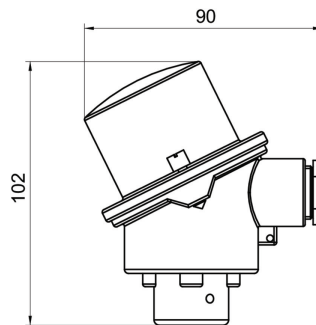

DIN Form B housing, dual transmitter

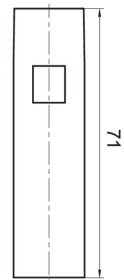

Cooling neck

Process connection

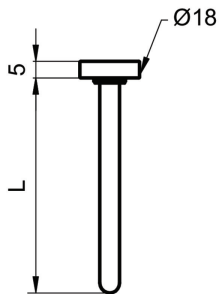

Without thread (BCID: T65)

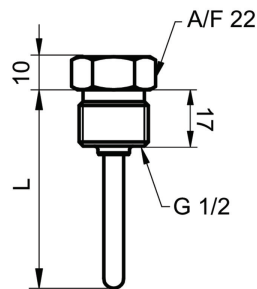

G 1/2 A DIN 3852-A (BCID: G44)

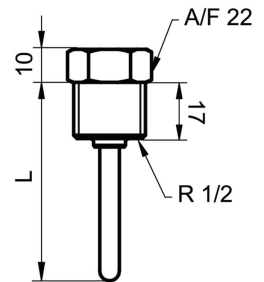

R 1/2 ISO 7/1 (BCID: R01)

TCR6

Standard RTD temperature sensor

TCR6-####-##0#-####-####-####

Dimensional drawings (mm)

Process connection

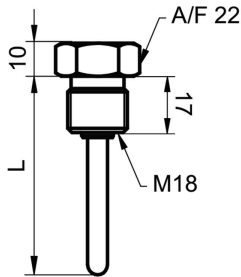

M18 × 1.5 ISO 261 / ISO 965 (BCID: M07)

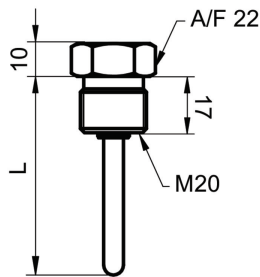

M20 × 1.5 ISO 261 / ISO 965 (BCID: M08)

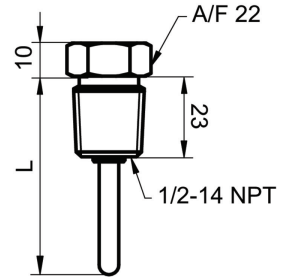

1/2-14 NPT (BCID: N02)

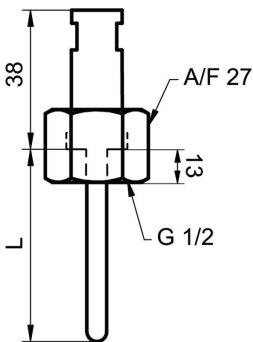

Rotating female union G 1/2 A ISO 228-1 (BCID: G23)

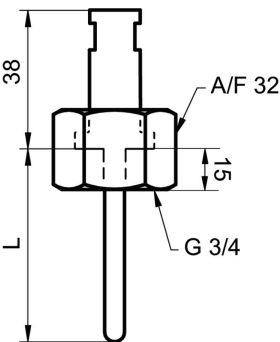

Rotating female union G 3/4 A ISO 228-1 (BCID: G24)

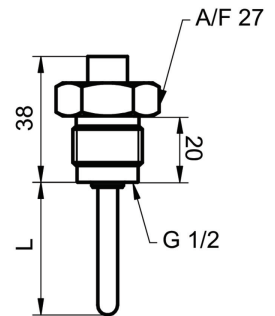

Rotating male nipple G 1/2 A ISO 228-1 (G06)

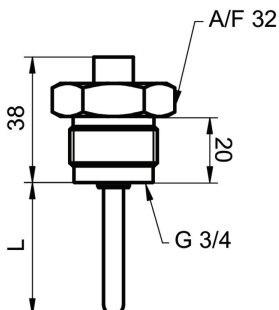

Rotating male nipple G 3/4 A ISO 228-1 (G10)

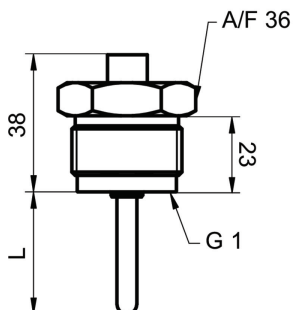

Rotating male nipple G 1 A ISO 228-1 (G11)

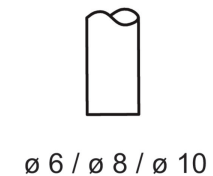

Standard response tip

TCR6

Standard RTD temperature sensor

TCR6-####-##0#-####-####-####

Dimensional drawings (mm)

Process connection

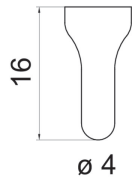

Fast response tip

TCR6

Standard RTD temperature sensor

TCR6-####-##0#-####-####-####

Electrical connection

Output type	Equivalent circuit	Electrical connection	Function	Pin assignment
Pt100 (Single element)			Pt100 11	Long
			Pt100 12	Short
			Pt100 11	1, 2
			Pt100 12	3, 4
			Pt100 11	1, 2
			Pt100 12	3, 4
Pt100 (Double element)			Pt100 11	Long
			Pt100 12	Long
			Pt100 21	Short
			Pt100 22	Short
			Pt100 11	1
			Pt100 12	2
			Pt100 21	3
			Pt100 22	4
4 ... 20 mA, 2-wire			+Vs	1
			lout	2
			+Vs	1
			lout	3
			N.C.	2, 4
			Frame ground	Plug thread
2 x 4 ... 20 mA, 2-wire			+Vs1	1
			lout1	2
			+Vs2	3
			lout2	4

Ordering information

Ordering key - Configuration possibilities see website

Product

TCR6 - #### . # # # # . # # ## . # # # # . ####

TCR6

TCR6

Standard RTD temperature sensor

TCR6-####-##0#-####-####-####

Ordering information

Ordering key - Configuration possibilities see website

	TCR6	-	####	.	#	#	#	#	.	#	#	##	.	#	#	#	#	.	####	
Electrical connection/Housing																				
Electrical connection: M12-A, 4-pin Housing: DIN form B																				1120
Electrical connection: M16x1.5 cable gland, nickel plated brass Housing: DIN form B																				1520
Electrical connection: M16x1.5 cable gland, nickel plated brass, shielded Housing: DIN form B																				1620
Electrical connection: M20x1.5 cable gland, nickel plated brass Housing: DIN form B																				1720
Electrical connection: M16x1.5 cable gland, nickel plated brass Housing: DIN form B for dual transmitter																				2520
Electrical connection: M16x1.5 cable gland, nickel plated brass, shielded Housing: DIN form B for dual transmitter																				2620
Electrical connection: M20x1.5 cable gland, nickel plated brass Housing: DIN form B for dual transmitter																				2720
Transmitter / socket																				
Flying leads																				0
Ceramic socket Pt100																				1
Transmitter 2202 4 ... 20 mA, accuracy ±0,25 °C																				2
Transmitter 2212 4 ... 20 mA, accuracy < ±0.06°C																				6
Transmitter 2222 4 ... 20 mA + HART®, accuracy < ±0.06°C																				7
2 x Transmitter 2202 4 ... 20 mA, accuracy ±0,25 °C																				A
2 x Transmitter 2212 4 ... 20 mA, accuracy < ±0.06°C																				D
2 x Transmitter 2222 4 ... 20 mA + HART®, accuracy < ±0.06°C																				E
Safety																				
Standard																				0
Ex ia IIC T6/T5...T4 (Gas)																				1
Ex ec IIC T5...T4 (Gas)																				3
Ex ia Simple apparatus, gas and dust																				9
Configuration																				
No configuration																				0
Configuration of temperature range																				1

TCR6

Standard RTD temperature sensor

TCR6-####-##0#-####-####-####

Ordering information

Ordering key - Configuration possibilities see website

TCR6 - #### . # # # # . # # ## . # # # # . ####

Sensor element

None	0
1 x Pt100, 1/1 B EN 60751	1
2 x Pt100, 1/1 B EN 60751	2
1 x Pt100, 1/3 B EN 60751	5
2 x Pt100, 1/3 B EN 60751	6
1 x Pt100, 1/6 B EN 60751	7
2 x Pt100, 1/6 B EN 60751	8
1 x Pt100, 1/1 A EN 60751	A
2 x Pt100, 1/1 A EN 60751	B
1 x Pt100, 1/1 B EN 60751, < 600°C	C
1 x Pt1000, 1/1 B EN 60751	J
1 x Pt1000, 1/3 B EN 60751	K

Sensor insert type

Sensor tube with embedded sensor element 2-wire	1
Sensor tube with embedded sensor element 4-wire	2
Sensor tube with embedded 2x2-wire sensor element	4
Spring loaded insert, DIN 43762, 2-wire	5
Spring loaded insert, DIN 43762, 4-wire	6
Spring loaded insert, DIN 43762, 2x2-wire	7
Cable sensor Pt100 1/1 B EN 60751	A
Cable sensor Pt100 1/3 B EN 60751	B
Cable sensor Pt100 1/6 B EN 60751	C
Cable sensor Pt100 1/1 A EN 60751	D

Cooling neck

Without	0
71 mm	1
142 mm	2
213 mm	3

Process connection

Tube without connection (T65)	10
G 1/2 A DIN 3852-A (G44)	12
R 1/2 ISO 7/1 (R01)	13
M18 x 1.5 ISO 261 / ISO 965 (M07)	16
M20 x 1.5 ISO 261 / ISO 965 (M08)	17
1/2-14 NPT (N02)	18
G 1/2 A ISO 228-1 female thread (G23)	23
G 3/4 A ISO 228-1 female thread (G24)	24
Rotating male nipple G 1/2 A ISO 228-1 (G06)	33
Rotating male nipple G 3/4 A ISO 228-1 (G10)	35
Rotating male nipple G 1 A ISO 228-1 (G11)	36

Seal

Without	0
NBR	1

Sensor diameter

Ø6.0 mm, welded	5
Ø8.0 mm, welded	6
Ø10.0 mm, welded	8
No immersion tube, for insert only	9

TCR6

Standard RTD temperature sensor

TCR6-####-##0#-####-####-####

Ordering information

Ordering key - Configuration possibilities see website

TCR6 - #### . # # # # . # # ## . # # # # . ####

Sensor tip

Standard response tip	1
Fast response tip, ø 4 mm tip	2
Insert only, open, no immersion tube below process connection	A

Approvals

Standard approvals	0
Railway EN 50155	4

Sensor tube length (mm)

20 - 3000	####
-----------	------