

Gate Valve
COBRA-SMP

Operating Manual



Legal information

Operating Manual COBRA-SMP

All rights reserved. The contents provided herein must neither be distributed, copied, reproduced, edited or processed for any other purpose, nor otherwise transmitted, published or made available to a third party without the manufacturer's express written consent.

Subject to technical modification without prior notice.

KSB Italia SpA, Concorezzo 07/01/19

Contents

	Glossary.....	4
1	General	5
	1.1 Principles	5
	1.2 Target group	5
	1.3 Other applicable documents.....	5
	1.4 Symbols	5
2	Safety.....	6
	2.1 Key to safety symbols/markings	6
	2.2 General	6
	2.3 Intended use	7
	2.4 Personnel qualification and training	7
	2.5 Consequences and risks caused by non-compliance with this manual	7
	2.6 Safetyawareness.....	7
	2.7 Safety information for the operator/user	8
	2.8 Safety information for maintenance, inspection and installation	8
	2.9 Unauthorised modes of operation.....	8
3	General safety regulations	9
4	Transport/Temporary Storage/Disposal	11
	4.1 Checking the condition upon delivery	11
	4.2 Transport.....	11
	4.3 Storage/preservation	11
	4.4 Return to supplier.....	11
	4.5 Disposal.....	12
5	Valve Description	13
	5.1 General description	13
	5.2 Marking	13
	5.3 Operating data	13
	5.4 Fluids handled	13
	5.5 Design details	14
	5.6 Pressure/temperature ratings.....	14
	5.7 Materials	15
	5.8 Function	19
	5.9 Scope of supply.....	19
	5.10 Dimensions and weights	19
6	Installation at Site.....	20
	6.1 General information/Safety regulations	20
	6.2 Installation	20
7	Commissioning/Start-up/Shutdown.....	21
	7.1 Commissioning/Start-up.....	21
	7.1.1 Prerequisites for commissioning/start-up.....	21
	7.1.2 Actuation	21
	7.2 Shutdown.....	21
	7.2.1 Measures to be taken for shutdown	21
8	Servicing/Maintenance	22
	8.1 Safety regulations	22
	8.2 Maintenance	22
9	Trouble-shooting.....	24
	Index	25

Glossary

Technical literature

Refer to the product catalogue for the technical literature on our products at www.ksb.it

1 General

1.1 Principles

This operating manual is supplied as an integral part of the type series and variants indicated on the front cover. The manual describes the proper and safe use of this equipment in all phases of operation.

In the event of damage, immediately contact the KSB sales organisation responsible in order to maintain the right to claim under warranty.

1.2 Target group

This operating manual is aimed at the target group of trained and qualified specialist technical personnel.

1.3 Other applicable documents

Table 1: Overview of other applicable documents

Document	Contents
Type series booklet	Description of the valve
General assembly drawing ²⁾	Sectional drawing of the valve
Sub-supplier product literature ³⁾	Operating manuals and other product literature for the accessories

Observe the relevant manufacturer's product literature for the accessories.

1.4 Symbols

Table 2: Symbols used in this manual

Symbol	Description
✓	Conditions which need to be fulfilled before proceeding with the step-by-step instructions
▷	Safety instructions
⇒	Result of an action
⇔	Cross-references
1. 2.	Step-by-step instructions
	Note Recommendations and important information on how to handle the product

1) If any
 2) If inclusion in the scope of supply has been agreed; otherwise refer to the type series booklet.
 3) If inclusion in the scope of supply has been agreed.







2 Safety



All the information contained in this section refers to hazardous situations.

2.1 Key to safety symbols/markings

Table 3: Definition of safety symbols/markings

	DANGER This signal word indicates a high-risk hazard which, if not avoided, will result in death or serious injury.
	WARNING This signal word indicates a medium-risk hazard which, if not avoided, could result in death or serious injury.
	CAUTION This signal word indicates a hazard which, if not avoided, could result in damage to the machine and its functions.
	General hazard In conjunction with one of the signal words this symbol indicates a hazard which will or could result in death or serious injury.
	Electrical hazard In conjunction with one of the signal words this symbol indicates a hazard involving electrical voltage and identifies information about protection against electrical voltage.
	Machine damage In conjunction with the signal word CAUTION this symbol indicates a hazard for the machine and its functions.

2.2 General

This manual contains general installation, operating and maintenance instructions that must be observed to ensure safe valve operation and prevent personal injury and damage to property.

The safety information in all sections of this manual must be complied with.

The operating manual must be read and fully understood by the specialist personnel/operators responsible prior to installation and commissioning.

The contents of this operating manual must be available to the specialist personnel at the site at all times.

Instructions and information attached directly to the valve must always be complied with and kept in a perfectly legible condition at all times. This applies to, for example: flow direction arrow, manufacturer, type designation, nominal pressure, nominal size, year of construction and material.

The operator is responsible for ensuring compliance with all local regulations not taken into account in this operating manual.

The design, manufacture and testing of the valves are subject to a QM system to DIN EN ISO 9001. Compliance with these requirements, however, is based on normal, predominantly static loading.

Valves exposed to creep-rupture conditions have a limited service life and have to meet the applicable regulations stipulated in the technical codes.

In the case of customised special variants, further restrictions may apply with regard to the operating mode and service life. Please refer to the relevant sales literature for this information.

This operating manual does not take into account:

- Any eventualities or incidents which may occur during installation performed by the customer, operation and maintenance.
- Local regulations; the operator must ensure that such regulations are strictly observed by all, including the personnel called in for installation.

2.3 Intended use

- Only operate valves which are in perfect technical condition.
- Do not operate partially assembled valves.
- The valve must only be used for fluids specified in the product literature.
- Only operate the valve within the permissible operating range specified for pressure and temperature.
- The valve's design and rating are based on predominantly static loading in accordance with the codes applied. Consult the manufacturer if the valve is subjected to dynamic loads or any other additional influences.
- Consult the manufacturer about any other modes of operation not described in the product literature.

Prevention of foreseeable misuse

- Never exceed the permissible operating limits specified in the data sheet or product literature regarding pressure, temperature, etc.
- Observe all safety information and instructions in this operating manual.

2.4 Personnel qualification and training

All personnel involved must be fully qualified to transport, install, operate, maintain and inspect the product this manual refers to and be fully aware of the interaction between the valve and the system.

The responsibilities, competence and supervision of all personnel involved in transport, installation, operation, maintenance and inspection must be clearly defined by the operator.

Deficits in knowledge must be rectified by means of training and instruction provided by sufficiently trained specialist personnel. If required, the operator can commission the manufacturer/supplier to train the personnel.

Hands-on training at the valve must always be supervised by specialist technical personnel.

2.5 Consequences and risks caused by non-compliance with this manual

- Non-compliance with this operating manual will lead to forfeiture of warranty cover and of any and all rights to claims for damages.
- Non-compliance can, for example, have the following consequences:
 - Hazards to persons due to electrical, thermal, mechanical and chemical effects and explosions
 - Failure of important product functions
 - Failure of prescribed maintenance and servicing practices
 - Hazard to the environment due to leakage of hazardous substances

2.6 Safety awareness

In addition to the safety information contained in this manual and the intended use, the following safety regulations shall be complied with:

- Accident prevention, health and safety regulations
- Explosion protection regulations
- Safety regulations for handling hazardous substances
- Applicable standards, directives and laws

2.7 Safety information for the operator/user

Actuator-operated valves are intended for use in areas which cannot be accessed by unauthorised persons. Operation of these valves in areas which can be accessed by unauthorised persons is only permitted if appropriate protective devices are fitted at the site. This must be ensured by the operator.

- The operator shall fit contact guards for hot, cold and moving parts and check that the guards function properly.
- Do not remove any contact guards during operation.
- Provide the personnel with protective equipment and make sure it is used.
- Contain leakages (e.g. at the stem seal) of hazardous fluids (e.g. explosive, toxic, hot) so as to avoid any danger to persons and the environment. Adhere to all relevant laws.
- Eliminate all electrical hazards. (In this respect refer to the applicable national safety regulations and/or regulations issued by the local energy supply companies.)

2.8 Safety information for maintenance, inspection and installation

- Modifications or alterations of the valve require the manufacturer's prior consent.
- Use only original spare parts or parts authorised by the manufacturer. The use of other parts can invalidate any liability of the manufacturer for resulting damage.
- The operator ensures that maintenance, inspection and installation is performed by authorised, qualified specialist personnel who are thoroughly familiar with the manual.
- Carry out work on the valve during standstill only.
- The valve body must have cooled down to ambient temperature.
- The pressure in the valve body must have been released and the valve must have been drained.
- When taking the valve out of service always adhere to the procedure described in the manual. (☞ Section 7.2.1, Page 18)
- Decontaminate valves which handle fluids posing a health hazard.
- As soon as the work has been completed, re-install and re-activate any safety-relevant and protective devices. Before returning the product to service, observe all instructions on commissioning.







2.9 Unauthorised modes of operation







Never operate the valve outside the limits stated in the data sheet and in this operating manual.

The warranty relating to the operating reliability and safety of the valve supplied is only valid if the valve is used in accordance with its intended use.

(☞ Section 2.3, Page 7)

3 General safety regulations

	<p style="text-align: center;">DANGER</p> <p>Handling actuated valves Danger to life!</p> <ul style="list-style-type: none"> ▷ If the valves are fitted with actuators, ensure that the actuator's operating manual is also observed.
	<p style="text-align: center;">DANGER</p> <p>Surge pressure/water hammer potentially occurring at high temperatures Danger to life caused by burns or scalds!</p> <ul style="list-style-type: none"> ▷ The max. permissible valve pressure must not be exceeded (☞ Section 5, Page 14) . ▷ Use valves made of nodular cast iron or steel. ▷ Operator shall provide general safety measures for the system.
	<p style="text-align: center;">WARNING</p> <p>Fluids handled, consumables and supplies which are hot and/or pose a health hazard Hazard to persons and the environment!</p> <ul style="list-style-type: none"> ▷ Collect and properly dispose of flushing fluid and any fluid residues. ▷ Wear safety clothing and a protective mask if required. ▷ Observe all legal regulations on the disposal of fluids posing a health hazard.
	<p style="text-align: center;">WARNING</p> <p>Cold/hot piping and/or valve Risk of thermal injury!</p> <ul style="list-style-type: none"> ▷ Insulate the valve. ▷ <p>Attach warning signs.</p>
	<p style="text-align: center;">WARNING</p> <p>Impermissible piping forces Leakage from or rupture of the valve body!</p> <ul style="list-style-type: none"> ▷ Connect the pipes to the valve without transmitting any stresses or strains. ▷ Take constructional measures to prevent any piping forces from being transmitted to the valve.
	<p style="text-align: center;">WARNING</p> <p>Unqualified personnel performing work on the valve Risk of injury!</p> <ul style="list-style-type: none"> ▷ Always have repair and maintenance work performed by specially trained, qualified personnel.

	<p style="background-color: yellow; margin: 0;">CAUTION</p> <p>Condensation water forming in air-conditioning, cooling and refrigerating systems Ice forming! Blockage of actuating element! Damage due to corrosion!</p> <ul style="list-style-type: none"> ▷ Insulate the valve to prevent diffusion.
	<p style="background-color: yellow; margin: 0;">CAUTION</p> <p>Improper installation Damage to the valve!</p> <ul style="list-style-type: none"> ▷ Remove the caps prior to installation. ▷ Clean the mating flange faces. ▷ Protect the body and bonnet/cover from any impacts.
	<p style="background-color: yellow; margin: 0;">CAUTION</p> <p>Outdoor installation Damage due to corrosion!</p> <ul style="list-style-type: none"> ▷ Protect the valve appropriately against moisture.
	<p style="background-color: yellow; margin: 0;">CAUTION</p> <p>Painting of pipes Impairment of the valve's function and loss of information!</p> <ul style="list-style-type: none"> ▷ Protect stem and plastic components prior to applying paint. ▷ Protect printed name plates prior to applying paint.
	<p style="background-color: yellow; margin: 0;">CAUTION</p> <p>Impermissible load Damage to the actuating element!</p> <ul style="list-style-type: none"> ▷ Do not use the valve as a foothold.
	<p style="background-color: yellow; margin: 0;">CAUTION</p> <p>Improper reassembly Damage to the valve!</p> <ul style="list-style-type: none"> ▷ Reassemble the valve in accordance with the general rules of sound engineering practice. ▷ Use original spare parts only.

4 Transport/Temporary Storage/Disposal

4.1 Checking the condition upon delivery

1. On transfer of goods, check each packaging unit for damage.
2. In the event of in-transit damage, assess the exact damage, document it and notify KSB or the supplying dealer and the insurer about the damage in writing immediately.

4.2 Transport

The valves are delivered with the valve disc in the closed position. The valves are supplied ready for operation. Original spare parts are only ready for operation following assembly/installation and subsequent shell and leak testing of the valve.

4.3 Storage/preservation

If properly stored indoors, the equipment is protected for a maximum of 12 months. This allows commissioning to take place some time after delivery. We recommend that the following measures be taken:

- Store the valve in a dust-free and vibration-free, frost-proof room where the atmospheric humidity is as constant as possible (use suitable caps or film for protection).
- Close the valve using little force and store in the closed position.
- Protect the valve from contact with solvents, lubricants, fuels or other chemicals.

4.4 Return to supplier

1. Drain the valve as described in the manual.
2. Always flush and clean the valve, particularly if it has been used for handling noxious, explosive, hot or other hazardous fluids.
3. If the fluids handled by the system leave residues which might lead to corrosion damage when coming into contact with atmospheric humidity, or which might ignite when coming into contact with oxygen, the valve must also be neutralised and blown through with anhydrous inert gas for drying purposes.

4.5 Disposal

	WARNING
	<p>Fluids handled, consumables and supplies which are hot and/or pose a health hazard</p> <p>Hazard to persons and the environment!</p> <ul style="list-style-type: none">▷ Collect and properly dispose of flushing fluid and any fluid residues.▷ Wear safety clothing and a protective mask if required.▷ Observe all legal regulations on the disposal of fluids posing a health hazard.

1. Dismantle the valve. Collect greases and other lubricants during dismantling.
2. Separate and sort the valve materials, e.g. by:
 - Metals
 - Plastics
 - Electronic waste
 - Greases and other lubricants
3. Dispose of materials in accordance with current regulations or in another controlled manner.

5 Valve Description

5.1 General description

The sectional drawings below provide examples of the general design/configuration of the valve. For additional and more detailed information, refer to the respective type series booklet.

5.2 Marking

Table4: General marking

Nominal size	DN ...
Nominal pressure class	PN/CLASS ...

5.3 Operating data

Table 5: Operating properties

Characteristic	Value
Nominal pressure	PN 16
Nominal size	DN 40 - 300
Nominal size	
Max. permissible pressure [bar]	40
Min. permissible temperature [°C]	-10
Max. permissible temperature [°C]	+110

5.4 Fluids handled

- Service water
- Hot water
- Heating water
- Cooling water

* max temperature depending on working pressure, please check technical documentation

5.5 Design details

Design

Valves to type series booklet COBRA-SMP

- Internal screw Gate valve

5.6 Pressure/temperature ratings Table 6: Test pressure and operating pressure

COBRA-SMP

PN	DN	Shell test	Leak test (seat)	Permissible operating pressure ⁴⁾
		With water		
		Tests P10 and P11 to DIN EN 12266-1 or API598	Test P12, leakage rate A to DIN EN 12266-1 or API598	
		[bar]	[bar]	
16	40-300	24	17.6	-10 to + 110 °C 16

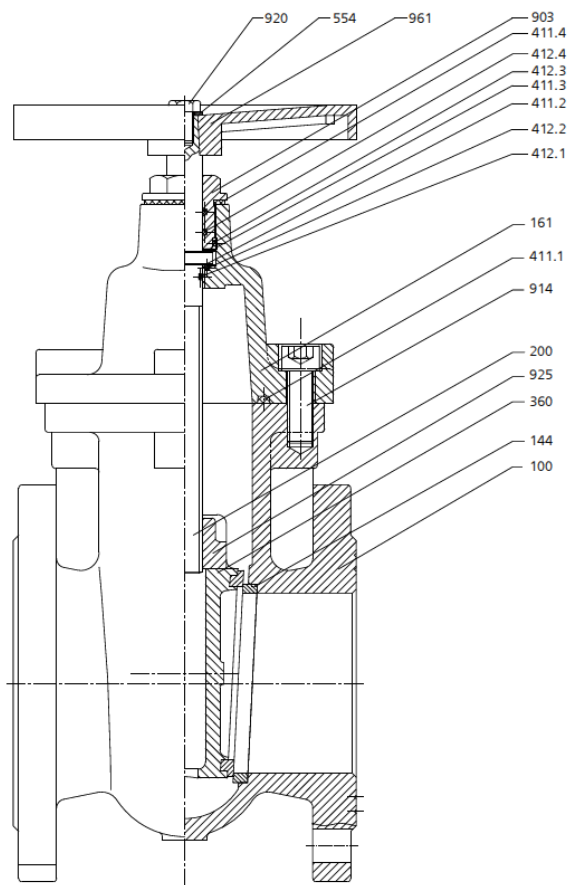

5.7 Materials

Table 7: Overview of available materials

Part No	Description	Material	Note
100	Body	EN-GJS-500-7	
144	Seat	Stainless steel	
360	Wedge	EN-GJS-500-7	
925	Stem nut	Cast brass	
200	Stem	Stainless steel	
914	Hexagon socket head cap screw	Steel	
411.1	Joint ring	Graphite	
161	Body bonnet	EN-GJS-500-7	
412.1	O-Ring	EPDM	
412.2	O-Ring	EPDM	
411.2	Backseat	PTFE	
411.3	Backseat	PTFE	
412.3	O-Ring	EPDM	
412.4	O-Ring	EPDM	
411.4	Joint ring	Graphite	
903	Screw plug	EN-GJL-250	
961	Handwheel	EN-GJL-250	
554	Washer	Steel	
920	Hexagon nut	Hexagon nut	

5**5.8 Function**

Gate valves, COBRA-SMP, are mainly used in building application, and they are ON-OFF valves.

The valve consists of the pressure retaining parts, i.e. body, body bonnet and the functional unit (wedge)

The functional unit mainly consists of a flexible wedge, the stem, and the actuating element, i.e. the handwheel.

The seating faces of the body and of the flexible wedge are in stainless steel. The sealing on the stem is performed by O-Rings.

5.9 Scope of supply

- Valve
- Operating manual for each packaging unit

5.10 Dimensions and weights

For dimensions and weights please refer to the type series booklet.

6 Installation at Site

6.1 General information/Safety regulations

Responsibility for positioning and installing the valve lies with the consultant, construction company or operator/user. Planning and installation errors may impair the reliable function of the valve and pose a substantial safety hazard.

6.2 Installation

	CAUTION
	<p>Welding in close proximity to soft-seated valves Damage to the seat/disc interface!</p> <ul style="list-style-type: none"> ▷ Ensure that the valve is not heated beyond the temperature limits specified in the type series booklet. ▷ The mating flange faces must be clean and undamaged. ▷ The gaskets on the mating flanges must be properly centered. Only fasteners and sealing elements made of approved materials shall be used. For the flange connection between valve and pipe use all flange bolt holes provided. Use suitable tools to tighten the bolts evenly and crosswise at the permissible torques.

Responsibility for welding the valves into the piping and for any heat treatment required lies with the commissioned company or the plant operator.

	CAUTION
	<p>Welding</p> <ul style="list-style-type: none"> ▷ When welding valves with butt or socket weld ends into the piping or when performing welding jobs on a pipeline after the valves have been installed (pipeline installation) make sure that no contamination enters the valve body and stays there, to prevent damage to the seat/disc interface or stem guiding elements. ▷ When welding the valve into the pipeline, take special precautions e.g. weld in several steps, so that the temperature rise in the middle of the valve body does not exceed the max. permissible operating temperature. The valve must be in 'open' position during welding. ▷ The welding cable (opposite pole) must not be attached to functional valve elements, to prevent scorching.

	CAUTION
	<p>Valves with actuators</p> <ul style="list-style-type: none"> ▷ Valves with transmission gear and/or actuators must be installed with the stem in vertical position, if possible. If this requirement cannot be met, adequately support the actuator on site or consult the manufacturer. ▷ Electrical connection shall be effected by suitably trained personnel only.

7 Commissioning/Start-up/Shutdown

7.1 Commissioning/Start-up

7.1.1 Prerequisites for commissioning/start-up

Before commissioning/start-up of the valve, ensure that the following requirements are met:

- The material, pressure and temperature data shown on the valve is in compliance with the operating conditions of the piping. (☞ Section 5, Page 14)
- The material's chemical resistance and stability under load have been checked.

	CAUTION
	<p>Welding beads, scale and other impurities in the piping Damage to the valve!</p> <ul style="list-style-type: none"> ▷ Remove any impurities from the piping. ▷ If necessary, install a strainer.

1. Thoroughly clean, flush and blow through all vessels, pipelines and connections (especially of new installations).
2. Remove the valve's flange covers before installing it in the piping.
3. Check that the inside of the valve is free from any foreign objects. Remove any foreign objects.
4. If required, install a strainer in the piping

Functional testing prior to commissioning/start-up

Check the shut-off function of the installed valve by opening and closing it several times.

7.1.2 Actuation

Viewed from above, the valve is closed by turning the handwheel in clockwise direction, and opened by turning the handwheel in counter-clockwise direction. Direction symbols are shown on the top of the handwheel.

Depending on the flow rate to be set, balancing valves are opened or set to the required valve plug position. As the valves are fitted with throttling plugs as standard, they are suitable for both on/off and control duties.

	CAUTION
	<p>Excessively long idle periods Damage to the valve!</p> <ul style="list-style-type: none"> ▷ Check the function by opening and closing the valve at least once or twice a year.

7.2 Shutdown



7.2.1 Measures to be taken for shutdown

During prolonged shutdown periods, ensure that the following conditions are met:

1. Drain fluids which change their physical condition due to changes in concentration, polymerisation, crystallisation, solidification, etc. from the piping.
2. If required, flush the piping with the valves fully opened.

8 Servicing/Maintenance

8.1 Safety regulations

	<p style="text-align: center;">WARNING</p> <p>Fluids, consumables and supplies which are hot and/or pose a health hazard Risk of injury!</p> <ul style="list-style-type: none"> ▷ Observe all relevant laws. ▷ When draining the fluid take appropriate measures to protect persons and the environment. ▷ Decontaminate valves used for handling fluids posing a health hazard.
	<p style="text-align: center;">WARNING</p> <p>Valve under pressure High-pressure hazard! Leakage of hot and/or toxic fluids! Risk of burns!</p> <ul style="list-style-type: none"> ▷ Never open the valve while it is pressurised. ▷ If there is fluid leakage, depressurise the valve. ▷ Ensure the valve is depressurised before removing any drain, opening or vent plugs. ▷ Ensure the valve is depressurised before removing it from the pipeline or before maintenance work. ▷ Allow the valve to cool down so that the temperature is below the fluid's vaporisation temperature in all areas in contact with the fluid in order to effectively prevent any risk of scalding.

Before removing the valve, ensure that the pipe has been shut off and released for repair/maintenance work.

A regular maintenance schedule will help avoid expensive repairs and contribute to trouble-free, reliable operation of the valve with a minimum of servicing/maintenance expenditure and work.

		<p style="text-align: center;">NOTE</p> <p>All maintenance, service and installation work can be carried out by KSB Service or authorised workshops. For contact details please refer to the enclosed "Addresses" booklet or visit "www.ksb.it" on the Internet.</p>
--	---	---

Never use force when dismantling and reassembling the valve.

8.2 Maintenance

The valve has been designed to be largely maintenance-free. The materials of the sliding parts have been selected to ensure minimum wear.

All elastomers are organic substances and as such subject to natural ageing. Continuous operation at high operating temperatures may reduce their service lives.

		<p style="text-align: center;">NOTE</p> <p>The user is responsible for defining appropriate intervals for checks and maintenance, depending on the application of the valve.</p>
--	---	---

The service life can be extended by taking the following measures:

- Checking the function by opening and closing the valve at least once or twice a year
- Lubricating the moving parts such as stem and stem nut using standardized lubricants to DIN 51825.
- Re-tightening or replacing the bonnet/cover O-Rings in good time.

9 Trouble-shooting

	WARNING
	<p>Improper remedial work on the valve</p> <p>Risk of injury!</p> <ul style="list-style-type: none"> ▷ For any work performed in order to remedy faults on the valve observe the relevant information given in this operating manual and/or the product literature provided by the accessories manufacturers.

If problems occur that are not described in the following table, consultation with the KSB customer service is required.

Table 8: Trouble-shooting

Problem	Remedy
Leakage at the bonnet/cover gasket	Re-tighten the screwed bonnet and/or fit a new joint ring.
Leakage at stem seal	Rework not possible. Replace valve.

Index

C

Commissioning 21

D

Design details 14

Disposal 12

F

Faults

Causes and remedies

Function 19

I

Intended use 6

M

Maintenance 22

Marking 13

Materials

COBRA-SMP 15

O

Operating data

COBRA-SMP 13

Operating ranges 13

Other applicable documents 5

P

Pressure/temperature ratings

COBRA-SMP 14

R

Return to supplier 11

S

Safety 6

Safety awareness 7

Scope of supply 19

Shutdown 21

Storage 12



KSB Italia SpA

Via M. D'Azeglio 32 • 20863 Concorezzo MB (Italy)

Tel. +39 039 60481

www.ksb.com

V1910801.1