

In-line Pump

Etaline-R

Fixed Speed / Variable Speed
50 Hz / 60 Hz

Type Series Booklet



Legal information/Copyright

Type Series Booklet Etaline-R

All rights reserved. The contents provided herein must neither be distributed, copied, reproduced, edited or processed for any other purpose, nor otherwise transmitted, published or made available to a third party without the manufacturer's express written consent.

Subject to technical modification without prior notice.

© KSB SE & Co. KGaA, Frankenthal 09/04/2019

Contents

Heating / Air-conditioning / Ventilation	5
In-line Pumps.....	5
Etaline-R.....	5
Main applications.....	5
Fluids handled	5
Further information on fluids handled.....	5
Related documents	5
Operating data.....	5
Design details	6
Designation	7
Materials.....	7
Coating and preservation	8
Product benefits	8
Product information	8
Product information as per Regulation No. 1907/2006 (REACH)	8
Product information as per Regulation No. 547/2012 (for water pumps with a maximum shaft power of 150 kW) implementing "Ecodesign" Directive 2009/125/EC	8
Acceptance tests and warranty	8
Overview of product features / selection tables	9
Overview of variants.....	9
Overview of fluids handled	10
Overview of functions.....	12
Pressure limits and temperature limits	13
Technical data	13
Pump.....	13
Motor (fixed speed version), n = 1450 rpm	14
Motor (fixed speed version), n = 1750 rpm	17
Selection charts	19
Etaline-R, n = 1450 rpm (fixed speed version).....	19
Etaline / Etaline-R (fixed speed version), n = 1750 rpm	19
Characteristic curves.....	20
General	20
Etaline-R, n = 1450 rpm (fixed speed version).....	21
Etaline-R 150-500, n = 1450 rpm	21
Etaline-R 200-330, n = 1450 rpm	22
Etaline-R 200-400, n = 1450 rpm	23
Etaline-R 200-500, n = 1450 rpm	24
Etaline-R 250-250, n = 1450 rpm	25
Etaline-R 250-260, n = 1450 rpm	26
Etaline-R 250-300, n = 1450 rpm	27
Etaline-R 250-330, n = 1450 rpm	28
Etaline-R 250-400, n = 1450 rpm	29
Etaline-R 250-500, n = 1450 rpm	30
Etaline-R 300-360, n = 1450 rpm	31
Etaline-R 300-400, n = 1450 rpm	32
Etaline-R 300-500, n = 1450 rpm	33
Etaline-R 350-340, n = 1450 rpm	34
Etaline-R, n = 1750 rpm (fixed speed version).....	35
Etaline-R 200-330, n = 1750 rpm	35
Etaline-R 200-400, n = 1750 rpm	36
Etaline-R 250-250, n = 1750 rpm	37
Etaline-R 250-260, n = 1750 rpm	38
Etaline-R 250-300, n = 1750 rpm	39
Etaline-R 250-330, n = 1750 rpm	40
Etaline-R 250-400, n = 1750 rpm	41
Etaline-R 300-360, n = 1750 rpm	42
Etaline-R 300-400, n = 1750 rpm	43
Etaline-R 350-340, n = 1750 rpm	44
Dimensions and connections	45
Pump set (fixed speed version), n = 1450 rpm / 1750 rpm.....	45
Connections.....	49
Flange design	49

General assembly drawings	50
General assembly drawing with list of components	50

Heating / Air-conditioning / Ventilation

In-line Pumps

Etaline-R



Operating data

Operating properties

Characteristic		Value	
		50 Hz	60 Hz
Flow rate	Q [m ³ /h]	≤ 1900	≤ 2280
	Q [l/s]	≤ 528	≤ 633
Head	H [m]	≤ 93	≤ 139
Fluid temperature	T [°C]	≥ -30	≥ -30
		≤ +140	≤ +140
Operating pressure	p [bar]	≤ 25	≤ 25

Main applications

- Service water supply systems
- Heating systems
- Industrial recirculation systems
- Air-conditioning systems
- Cooling circuits
- Water supply systems¹⁾

Fluids handled

- Fluids not chemically or mechanically aggressive to the materials

Further information on fluids handled

Overview of fluids handled (⇒ Page 10)

Related documents

Information/documents

Document	Reference number
Type series booklet KSB SuPremE	4075.53
Type series booklet PumpDrive 2 / PumpDrive 2 Eco	4074.5
Type series booklet PumpMeter	4072.5

1) No drinking water in acc. with UBA (German drinking water regulations to German Environment Agency)

Design details

Design

- Close-coupled design / in-line design
- Single-stage
- Vertical installation
- Rigid connection between pump and motor
- Fixed speed version (without PumpDrive) / variable speed version (with PumpDrive)

Pump casing

- Radially split volute casing

Drive (fixed speed version)

Standard design:

- KSB/Siemens surface-cooled IEC frame three-phase squirrel-cage motor
- Efficiency class IE1 (size 71/80) / IE3 (from size 90) to IEC 60034-30
- Rated voltage (50 Hz) 230 V / 400 V \leq 2.20 kW
- Rated voltage (50 Hz) 400 V / 690 V \geq 3.00 kW
- Rated voltage (60 Hz) - / 460 V \leq 2.20 kW
- Rated voltage (60 Hz) 460 V / - \geq 3.00 kW
- Type of construction IM V1
- Enclosure IP55
- Duty cycle: continuous duty S1
- Thermal class F with temperature sensor, 1 PTC thermistor (size 80/90) / 3 PTC thermistors (from size 100)

Explosion-proof design:

- KSB surface-cooled IEC three-phase current squirrel-cage motor
- Efficiency class IE2 / IE3 to IEC 60034-30
- Rated voltage (50 Hz) 230 V / 400 V \leq 2.50 kW
- Rated voltage (50 Hz) 400 V / 690 V \geq 3.30 kW
- Rated voltage (60 Hz) - / 460 V \leq 2.50 kW
- Rated voltage (60 Hz) 460 V / - \geq 3.30 kW
- Type of construction IM V1
- Enclosure IP55
- Duty cycle: continuous duty S1
- Type of protection EEx eb II
- Temperature class T3

Drive (variable speed version)

KSB SuPremE motor:

- Surface-cooled KSB SuPremE motor, IEC-compatible, magnetless synchronous reluctance motor (PumpDrive required)
- Efficiency class IE4/IE5 to IEC TS 60034-30-2:2016
- Mounting points to EN 50347:2001
- Envelope dimensions to DIN VDE 42673-4:2011-07
- Type of construction IM V1
- Enclosure IP55
- Duty cycle: continuous duty S1
- Thermal class F with temperature sensor, 3 PTC thermistors
- Shaft centreline height 71 to 225 mm

- Rated power 0.55 kW to 45 kW
- Rated speed 1500 rpm or 3000 rpm
- Frequency 50 Hz / 60 Hz (PumpDrive input)
- Voltage 380 V to 480 V (PumpDrive input)

KSB SuPremE X1:

- With terminal box for connecting to PumpDrive 2 or PumpDrive R for mounting on walls and in control cabinets

KSB SuPremE X2:

- Equipped for being fitted with a motor-mounted PumpDrive 2

PumpDrive 2:

- Self-cooling frequency inverter of modular design for the continuously variable speed control of asynchronous reluctance motors and synchronous reluctance motors by means of analog standard signals, a field bus or the control panel
- Identical design of frequency inverter for motor mounting, wall mounting and cabinet mounting
- Mains voltage 3~ 380 V AC -10 % to 480 V AC +10 %
- Mains frequency 50 Hz to 60 Hz \pm 2 %

PumpMeter:

- Intelligent pressure transmitter for pumps, with on-site display of measured values and operating data
- For recording the load profile of the pump
- Supplied completely assembled and parameterised for the individual pump

Shaft seal

- KSB mechanical seal

Impeller type

- Closed radial impeller

Bearings

- Radial ball bearing in the bearing bracket
- Grease lubrication

Designation

Example: Etaline-R GN 300-400/31504

Designation key

Code	Description	
Etaline	Type series	
R	Extended selection chart	
G	Material combination volute casing / casing cover / impeller	
	G	Nodular cast iron / grey cast iron / grey cast iron
	GC	Nodular cast iron / grey cast iron / stainless steel
	M	Nodular cast iron / grey cast iron / tin bronze
	S	Nodular cast iron / nodular cast iron / grey cast iron
	SC	Nodular cast iron / nodular cast iron / stainless steel
	SM	Nodular cast iron / nodular cast iron / tin bronze
N	Stub shaft design and standardised motor	
300	Nominal discharge nozzle diameter [mm]	
400	Nominal impeller diameter [mm]	
3150	Motor rating × 10, e.g. 315 kW	
4	Number of motor poles	

Materials

Symbols key

Symbol	Description
X	Standard
-	Version not available / not feasible

Overview of available materials

Part No. (⇒ Page 50)	Description	Material	Material variant					
			GN	GCN	MN	SN	SCN	SMN
102	Volute casing	Nodular cast iron EN-GJS-400-18-LT	X	X	X	X	X	X
161	Casing cover	Grey cast iron EN-GJL-250	X	X	X	-	-	-
		Nodular cast iron EN-GJS-400-18-LT	-	-	-	X	X	X
210	Shaft	Tempered steel C45	X	X	X	X	X	X
		Stainless steel 1.4057 (optional)	X	X	X	X	X	X
230	Impeller	Grey cast iron EN-GJL-250	X	-	-	X	-	-
		Stainless steel 1.4408	-	X	-	-	X	-
		Tin bronze CC480K-GS	-	-	X	-	-	X
330	Bearing bracket	Grey cast iron EN-GJL-250	X	X	X	X	X	X
400	Sealing elements	DPAF, asbestos-free	X	X	X	X	X	X
502	Casing wear ring Casing/discharge cover	Grey cast iron EN-GJL-250	X	X	-	X	X	-
		Lead bronze CC495K-GS	-	-	X	-	-	X
902.01	Studs	1.7709	X	X	X	-	-	-
		1.6772	-	-	-	X	X	X
920.01	Nut	1.7218	X	X	X	-	-	-
		1.6772	-	-	-	X	X	X
920.95	Impeller nut	Stainless steel 1.4571	X	X	X	X	X	X

Coating and preservation

- Coating and preservation to KSB standard

Product benefits

- Improved efficiency and NPSHreq by experimentally verified hydraulic design of impellers (vanes)
- Operating costs reduced by trimming the nominal impeller diameter to match the specified duty point
- Little wear, low vibration levels and excellent smooth running characteristics thanks to good suction performance and virtually cavitation-free operation across a wide operating range
- Casing sealed reliably – even in varying operating conditions – by confined casing gasket
- Optimum match of pump to fluid handled by a large choice of materials for many applications as standard

Product information

Product information as per Regulation No. 1907/2006 (REACH)

For information as per chemicals Regulation (EC) No 1907/2006 (REACH), see <http://www.ksb.com/reach>.

Product information as per Regulation No. 547/2012 (for water pumps with a maximum shaft power of 150 kW) implementing "Ecodesign" Directive 2009/125/EC

- Minimum efficiency index: see data sheet
- The benchmark for the most efficient water pumps is MEI ≥ 0.70 .
- Year of construction: see data sheet
- Manufacturer's name or trade mark, commercial registration number and place of manufacture: see data sheet or order documentation
- Product's type and size identifier: see data sheet
- Hydraulic pump efficiency (%) with trimmed impeller: see data sheet
- Pump performance curves, including efficiency characteristics: see documented characteristic curve
- The efficiency of a pump with a trimmed impeller is usually lower than that of a pump with full impeller diameter. Trimming of the impeller will adapt the pump to a fixed duty point, leading to reduced energy consumption. The minimum efficiency index (MEI) is based on the full impeller diameter.
- Operation of this water pump with variable duty points may be more efficient and economic when controlled, for example, by the use of a variable speed drive that matches the pump duty to the system.
- Information relevant for disassembly, recycling or disposal at end of life: see installation/operating manual
- Information on benchmark efficiency or benchmark efficiency graph for MEI = 0.70 (0.40) for the pump based on the model shown in the Figure are available at: <http://www.europump.org/efficiencycharts>

Acceptance tests and warranty

The following acceptance tests may be performed at a surcharge:

- **Materials testing**
 - Test report 2.2
- **Final inspection**
 - Inspection certificate 3.1 to EN 10204
- **Hydraulic test**
 - The duty point of each pump is guaranteed according to ISO 9906/2B or ISO 9906/3B.
 - NPSH test
- Other inspections/tests on request

Warranties

- Warranties are given within the scope of the valid delivery conditions.

Overview of product features / selection tables

Overview of variants

Other designs on request

Symbols key

Symbol	Description
X	Standard
-	Version not available / not feasible

Overview of Etaline-R variants

Variant	102 / Volute casing	230 / Impeller	Mechanical seal	T [°C]	Main applications						MPG
					Handling clean or aggressive fluids not chemically and mechanically aggressive to the pump materials	Water supply systems	Cooling circuits	Heating systems	Air-conditioning systems		
GN 01	Nodular cast iron EN-GJS-400-18_LT	Grey cast iron EN-GJL-250 / A 48 CL 35 B	Mechanical seal Q1BEGG	≥ -30 - ≤ +110	X	X	X	-	X	35	
GN 05	Nodular cast iron EN-GJS-400-18_LT	Grey cast iron EN-GJL-250 / A 48 CL 35 B	Mechanical seal Q1AEGG	≥ -30 - ≤ +140	-	-	-	X	X	35	
SN 01	Nodular cast iron EN-GJS-400-18_LT	Grey cast iron EN-GJL-250 / A 48 CL 35 B	Mechanical seal Q1BEGG	≥ -30 - ≤ +110	X	X	X	-	X	35	
SN 05	Nodular cast iron EN-GJS-400-18_LT	Grey cast iron EN-GJL-250 / A 48 CL 35 B	Mechanical seal Q1AEGG	≥ -30 - ≤ +140	-	-	-	X	X	35	

Overview of fluids handled

KSB EasySelect, selection software for all applications



KSB EasySelect is a comprehensive selection tool for all applications. It guides users to an optimal solution for their projects by offering a fast, easy and user-friendly way to select and configure pumps and valves. All that is required are some project-specific criteria and a few minutes' time. The tool systematically guides the user through KSB's wide range of products to the right product for the application at hand.

Other fluids upon request.

Symbols key

Symbol	Description
X	Standard
-	Version not available / not feasible

Excerpt from the overview of fluids handled with associated material variants

Fluid handled	Application limits	Material				Design code
		Casing/impeller			Mechanical seal	Mechanical seal
		G	M	S	4	
Water						
Service water	t ≤ 60 °C; p ≤ 16 bar	X	-	-	X	G4
Fire-fighting water ²⁾	t ≤ 60 °C; p ≤ 16 bar	-	X	-	X	M4
Heating water ³⁾	t ≤ 120 °C; p ≤ 16 bar	X	-	-	X	G4
Heating water ³⁾	t ≤ 140 °C; p ≤ 25 bar	-	-	X	X	S4
Heating water ³⁾	t ≤ 110 °C; p ≤ 16 bar	X	-	-	X	G4
Condensate ³⁾	t ≤ 120 °C; p ≤ 16 bar	X	-	-	X	Contact the manufacturer.
Cooling water ²⁾ (without antifreeze)	t ≤ 60 °C; p ≤ 16 bar	X	-	-	X	G4
Cooling water pH ≥ 7.5 (with antifreeze) ⁴⁾	t ≥ -30 °C; p ≤ 16 bar t ≤ 110 °C; p ≤ 25 bar	X -	- -	- X	X -	G4
Slightly contaminated water ²⁾	t ≤ 60 °C; p ≤ 16 bar	X	-	-	X	G4
Pure water ⁵⁾	t ≤ 25 °C; p ≤ 16 bar	X	-	-	X	G4
Raw water (irrigation) ²⁾	t ≤ 60 °C; p ≤ 16 bar	X	-	-	X	G4
Raw water (industrial application) ²⁾	t ≤ 60 °C; p ≤ 16 bar	X	-	-	X	G4
Swimming pool water (fresh water) ²⁾	t ≤ 60 °C; p ≤ 16 bar	X	-	-	X	G4
Dam water ²⁾	t ≤ 60 °C; p ≤ 16 bar	-	X	-	X	M4
Drinking water ²⁾	t ≤ 60 °C; p ≤ 16 bar	-	X	-	X	M4
Partly desalinated water ³⁾	t ≤ 120 °C; p ≤ 16 bar	X	-	-	X	Contact the manufacturer.
Fully desalinated water as boiler feed water ³⁾	t ≤ 120 °C; p ≤ 16 bar	X	-	-	X	G4
Refrigerants, cooling brines						
Cooling brine, inorganic, pH ≥ 7.5, inhibited	t ≥ -30 °C; p ≤ 16 bar t ≤ 25 °C	X	-	-	X	G4
Water with antifreeze pH ≥ 7.5 ²⁾⁴⁾	t ≥ -30 °C; p ≤ 16 bar t ≤ 110 °C	X	-	-	X	G4
Oils/emulsions						
Diesel oil, extra light fuel oil	t ≤ 60 °C; p ≤ 16 bar	-	-	X	X	S4
Lubricating oil, turbine oil, does not apply to SF-D oils (hardly flammable)	t ≤ 80 °C; p ≤ 16 bar	-	-	X	X	S4
Drilling emulsion, grinding emulsion	t ≤ 60 °C; p ≤ 16 bar	X	-	-	X	G4
Oil-water emulsion	t ≤ 60 °C; p ≤ 16 bar	X	-	-	X	G4

- 2) General evaluation criteria for results of water analysis: pH > 7; chlorides content (Cl-) < 250 mg/kg. Chlorine (Cl2) < 0.6 mg/kg
 3) Treatment to VdTUV 1466; additional requirement: O2 < 0.02 mg/l
 4) Antifreeze agent on ethylene glycol basis with inhibitors. Content: > 20 % to 50 % (e.g. Antifrogen N)
 5) No ultra-pure water! Electrical conductivity at 25 °C: < 800 µS/cm, neutral with regard to chemical corrosion

Fluid handled	Application limits	Material				Design code
		Casing/impeller			Mechanical seal	Mechanical seal
		G	M	S	4	
Cleaning agents						
Lyes for bottle rinsers	$t \leq 90 \text{ }^\circ\text{C}$; $p \leq 16 \text{ bar}$	X	-	-	-	-
Brewery applications						
Beer mash	$t \leq 100 \text{ }^\circ\text{C}$; $p \leq 16 \text{ bar}$	X	-	-	X	G4
Beer wort	$t \leq 100 \text{ }^\circ\text{C}$; $p \leq 16 \text{ bar}$	X	-	-	X	G4

Overview of functions

Overview of functions

Functions / Firmware	PumpDrive 2 Eco	PumpDrive 2
Protective functions		
Thermal motor protection	X	X
Mains voltage monitoring	X	X
Phase failure, motor side	X	X
Short-circuit monitoring, motor side (phase to phase and phase to earth)	X	X
Dynamic overload protection by speed limitation (i ² t control)	X	X
Suppression of resonance frequencies	X	X
Cable integrity monitoring (Live Zero)	X	X
Protection against dry running and hydraulic blockage (sensorless due to learning function)	X	X
Dry running protection (external control signal)	X	X
Operating point estimation and characteristic curve control	X	X
Open-loop control		
Open-loop control mode	X	X
Closed-loop control		
Closed-loop control mode via integrated PID controller	X	X
Pressure/differential pressure control (Δp const)	X	X
Pressure/differential pressure control with dynamic pressure compensation (Δp var)	X	X
Flow rate control	X	X
Sensorless differential pressure control (Δp const) in a single-pump configuration	X	X
Sensorless differential pressure control with dynamic pressure compensation (Δp var) in a single-pump configuration	X	X
Sensorless flow rate control	X	X
Level control	X	X
Temperature control	X	X
Alternative setpoint	-	X
Operation and monitoring (display)		
Measured value display (pressure, head, speed, electric power, motor voltage, motor current, torque)	X	X
Fault history	X	X
Operating hours counter	X	X
Fault reporting via relay	X	X
Frequency inverter functions		
Programmable start ramps and stop ramps	X	X
Field-oriented control (vector control), V/f control	X	X
Configurable motor control method (asynchronous motor, KSB SuPremE)	X	X
Automatic motor adaptation (AMA)	X	X
Motor standstill heater	X	X
Manual-0-automatic mode	X	X
External OFF	X	X
External minimum speed	X	X
Sleep mode (stand-by mode)	X	X
Energy savings meter	-	X
Pump functions		
Flow rate estimation	X	X
M12 module with PumpMeter bus connection	X	X
M12 module for dual-pump configuration	X	X
M12 module for multiple pump configuration with up to 6 pumps	X	X
Functional check run	X	X
Integrated dual-pump configuration (1x100 % with redundant pump or 2x50 % without redundant pump)	X	X
Multiple pump configuration with up to 6 pumps	X	X
Waste water function: start-up at maximum speed	-	X
Waste water function: flushing function	-	X
Operation		

Functions / Firmware	PumpDrive 2 Eco	PumpDrive 2
Control panel	✗ ⁶⁾	✗
Commissioning wizard	✗ ⁷⁾	✗
Favourites list	-	✗
Service interface	✗	✗

Pressure limits and temperature limits

Pressure limits and temperature limits as a function of material variant

Material variant	Fluid temperature ⁸⁾⁹⁾	Test pressure ¹⁰⁾
	[°C]	[bar]
GN, MN, GCN	-30 to +140	≤ 24
SN, SCN, SMN	-30 to +140	≤ 37,5

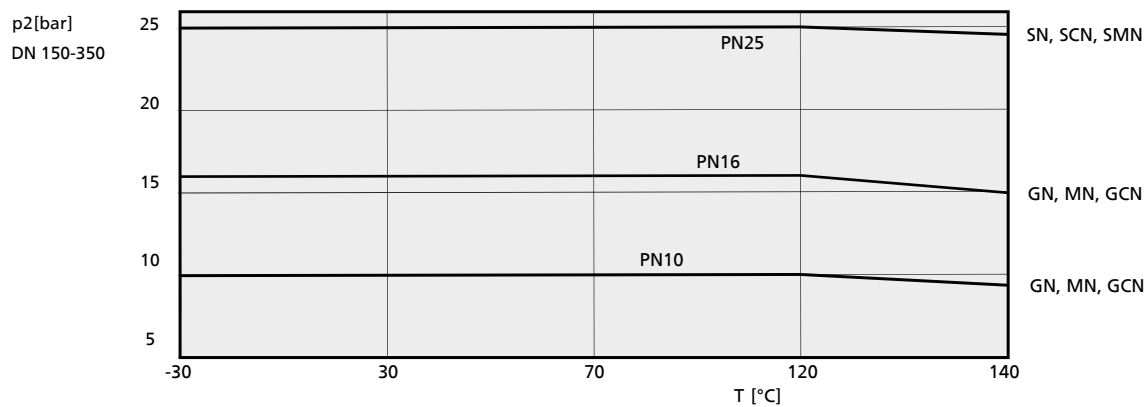

Fig. 1: Operating pressure limits and temperature limits of an Etaline-R pump

Technical data

Pump

Technical data of Etaline-R

Etaline-R	Shaft unit	Impeller				Speed limit	
		Impeller outlet width	Impeller inlet diameter	Nominal diameter		Minimum	Maximum
				Minimum	Maximum		
		[mm]				[rpm]	
150-500	WE65	21,0	200	410	500	300	1500
200-330	WE65	54,0	220	270	330	300	1800
200-400	WE65	38,0	240	340	405	300	1800
200-500	WE65	36,0	220	420	510	300	1500
250-250	WE65	57,0	213	200	240	300	1800
250-260	WE65	62,0	190	240	260	300	1800
250-300	WE65	66,5	248	245	285	300	1800
250-330	WE65	72,0	240	290	330	300	1800
250-400	WE65	58,0	280	340	405	300	1800
250-500	WE65	44,0	260	440	520	300	1500
300-360	WE65	78,0	260	320	360	300	1800
300-400	WE65	65,0	290	360	430	300	1800
300-500	WE65	56,0	290	450	520	300	1500
350-340	WE65	74,5	278	320	270	300	1800

6) Some functions can only be parameterised and/or displayed using the KSB ServiceTool (see operating manual).

7) Only available via KSB ServiceTool and app

8) For hot water heating systems to DIN 4752, Section 4.5, application limits must be observed.

9) For fluid temperatures >140 °C use Etanorm SYT.

10) The casing components are checked for leakage by means of internal pressure tests to AN 1897/75-03D00 with water.

Motor (fixed speed version), n = 1450 rpm

Etaline-R, n = 1450 rpm

Etaline-R	Motor			[kg]
	Size	[kW]	400 V	
			[A]	
150-500/3004	200L	30,00	55,00	884
150-500/3704	225S	37,00	66,00	965
150-500/4504	225M	45,00	80,00	1015
150-500/5504	250M	55,00	96,00	1205
150-500/7504	280S	75,00	133,00	1305
150-500/9004	228M	90,00	157,00	1485
150-500/11004	315S	110,00	191,00	1571
150-500/13204	315M	132,00	230,00	1796
150-500/16004	315L	160,00	275,00	1896
200-330/1504	160L	15,00	28,50	724
200-330/1854	180M	18,50	35,00	748
200-330/2204	180L	22,00	41,00	770
200-330/3004	200L	30,00	55,00	814
200-330/3704	225S	37,00	66,00	895
200-330/4504	225M	45,00	80,00	945
200-330/5504	250M	55,00	96,00	1145
200-330/7504	280S	75,00	133,00	1245
200-330/9004	228M	90,00	157,00	1425
200-330/11004	315S	110,00	191,00	1511
200-400/3004	200L	30,00	55,00	989
200-400/3704	225S	37,00	66,00	1070
200-400/4504	225M	45,00	80,00	1120
200-400/5504	250M	55,00	96,00	1315
200-400/7504	280S	75,00	133,00	1415
200-400/9004	228M	90,00	157,00	1595
200-400/11004	315S	110,00	191,00	1681
200-400/13204	315M	132,00	230,00	1906
200-400/16004	315L	160,00	275,00	2006
200-400/2004	315L	200,00	340,00	2006
200-500/4504	225M	45,00	80,00	1190
200-500/5504	250M	55,00	96,00	1380
200-500/7504	280S	75,00	133,00	1480
200-500-9004	228M	90,00	157,00	1660
200-500/11004	315S	110,00	191,00	1746
200-500/13204	315M	132,00	230,00	1971
200-500/16004	315L	160,00	275,00	2071
200-500/20004	315L	200,00	340,00	2071
200-500/25004	315L	250,00	249,27	2185
250-250/754	132M	7,50	15,05	620
250-250/1104	160M	11,00	21,58	641
250-250/1504	160L	15,00	28,50	684
250-250/1854	180M	18,50	35,00	708
250-250/2204	180L	22,00	41,00	730
250-250/3004	200L	30,00	55,00	774
250-250/3704	225S	37,00	66,00	855
250-250/4504	225M	45,00	80,00	905
250-260/1104	160M	11,00	21,58	701
250-260/1504	160L	15,00	28,50	744
250-260/1854	180M	18,50	35,00	768
250-260/2204	180L	22,00	41,00	790
250-260/3004	200L	30,00	55,00	834
250-260/3704	225S	37,00	66,00	915
250-260/4504	225M	45,00	80,00	965
250-260/5504	250M	55,00	96,00	1165

Etaline-R	Motor			[kg]
	Size	[kW]	400 V	
			[A]	
250-300/1504	160L	15,00	28,50	899
250-300/1854	180M	18,50	35,00	923
250-300/2204	180L	22,00	41,00	945
250-300/3004	200L	30,00	55,00	989
250-300/3704	225S	37,00	66,00	1070
250-300/4504	225M	45,00	80,00	1120
250-300/5504	250M	55,00	96,00	1300
250-300/7504	280S	75,00	133,00	1400
250-300/9004	228M	90,00	157,00	1580
250-330/2204	180L	22,00	41,00	910
250-330/3004	200L	30,00	55,00	954
250-330/3704	225S	37,00	66,00	1035
250-330/4504	225M	45,00	80,00	1085
250-330/5504	250M	55,00	96,00	1285
250-330/7504	280S	75,00	133,00	1385
250-330/9004	228M	90,00	157,00	1565
250-330/11004	315S	110,00	191,00	1651
250-330/13204	315M	132,00	230,00	1876
250-330/16004	315L	160,00	275,00	1976
250-400/3004	200L	30,00	55,00	1119
250-400/3704	225S	37,00	66,00	1200
250-400/4504	225M	45,00	80,00	1250
250-400/5504	250M	55,00	96,00	1445
250-400/7504	280S	75,00	133,00	1545
250-400/9004	228M	90,00	157,00	1725
250-400/11004	315S	110,00	191,00	1811
250-400/13204	315M	132,00	230,00	2036
250-400/16004	315L	160,00	275,00	2136
250-400/20004	315L	200,00	340,00	2136
250-400/25004	315L	250,00	249,27	2250
250-500/7504	280S	75,00	133,00	1760
250-500/9004	228M	90,00	157,00	1940
250-500/11004	315S	110,00	191,00	2026
250-500/13204	315M	132,00	230,00	2251
250-500/16004	315L	160,00	275,00	2351
250-500/20004	315L	200,00	340,00	2351
250-500/25004	315L	250,00	249,27	2465
250-500/31504	315L	318,84	315,00	2665
300-360/3704	225S	37,00	66,00	1470
300-360/4504	225M	45,00	80,00	1520
300-360/5504	250M	55,00	96,00	1715
300-360/7504	280S	75,00	133,00	1815
300-360/9004	228M	90,00	157,00	1995
300-360/11004	315S	110,00	191,00	2081
300-360/13204	315M	132,00	230,00	2306
300-360/16004	315L	160,00	275,00	2406
300-360/20004	315L	200,00	340,00	2406
300-400/5504	250M	55,00	96,00	1680
300-400/7504	280S	75,00	133,00	1780
300-400/9004	228M	90,00	157,00	1960
300-400/11004	315S	110,00	191,00	2046
300-400/13204	315M	132,00	230,00	2271
300-400/16004	315L	160,00	275,00	2371
300-400/20004	315L	200,00	340,00	2371
300-400/25004	315L	250,00	249,27	2485
300-400/31504	315L	315,00	318,84	2685
300-500/11004	315S	110,00	191,00	2171

Etaline-R	Motor			[kg]
	Size	[kW]	400 V	
			[A]	
300-500/13204	315M	132,00	230,00	2396
300-500/16004	315L	160,00	275,00	2496
300-500/20004	315L	200,00	340,00	2496
300-500/25004	315L	250,00	249,27	2610
300-500/31504	315L	315,00	318,84	2810
350-340/2204	180L	22,00	41,00	1195
350-340/3004	200L	30,00	55,00	1239
350-340/3704	225S	37,00	66,00	1320
350-340/4504	225M	45,00	80,00	1370
350-340/5504	250M	55,00	96,00	1565
350-340/7504	280S	75,00	133,00	1665
350-340/9004	228M	90,00	157,00	1845

Motor (fixed speed version), n = 1750 rpm

Etaline-R, n = 1750 rpm

Etaline-R	Motor			[kg]
	Size	[kW]	460 V ≈[A]	
200-330/1504	160L	17,30	24,00	707
200-330/1854	180M	21,30	30,50	726
200-330/2204	180L	25,30	36,50	746
200-330/3004	200L	34,50	47,00	796
200-330/3704	225S	42,50	60,00	890
200-330/4504	225M	52,00	70,00	930
200-330/5504	250M	63,00	86,00	1110
200-330/7504	280S	86,00	114,00	1225
200-330/9004	280M	104,00	144,00	1325
200-330/11004	315S	127,00	170,00	1460
200-400/3004	200L	34,50	47,00	971
200-400/3704	225S	42,50	60,00	1065
200-400/4504	225M	52,00	70,00	1105
200-400/5504	250M	63,00	86,00	1280
200-400/7504	280S	86,00	114,00	1395
200-400/9004	280M	104,00	144,00	1495
200-400/11004	315S	127,00	170,00	1630
200-400/13204	315M	152,00	225,00	1925
200-400/16004	315L	192,00	280,00	2125
200-400/20004	315L	230,00	335,00	2165
250-250/754	132M	8,60	12,80	620
250-250/1104	160M	12,60	18,20	641
250-250/1504	160L	17,30	24,00	667
250-250/1854	180M	21,30	30,50	693
250-250/2204	180L	25,30	36,50	710
250-250/3004	200L	34,50	47,00	764
250-250/3704	225S	42,50	60,00	850
250-250/4504	225M	52,00	70,00	890
250-260/1104	160M	12,60	18,20	701
250-260/1504	160L	17,30	24,00	727
250-260/1854	180M	21,30	30,50	746
250-260/2204	180L	25,30	36,50	766
250-260/3004	200L	34,50	47,00	816
250-260/3704	225S	42,50	60,00	910
250-260/4504	225M	52,00	70,00	950
250-260/5504	250M	63,00	86,00	1130
250-300/1504	160L	17,30	24,00	882
250-300/1854	180M	21,30	30,50	901
250-300/2204	180L	25,30	36,50	921
250-300/3004	200L	34,50	47,00	971
250-300/3704	225S	42,50	60,00	1065
250-300/4504	225M	52,00	70,00	1105
250-300/5504	250M	63,00	86,00	1265
250-300/7504	280S	86,00	114,00	1380
250-300/9004	280M	104,00	144,00	1480
250-330/2204	180L	25,30	36,50	886
250-330/3004	200L	34,50	47,00	936
250-330/3704	225S	42,50	60,00	1030
250-330/4504	225M	52,00	70,00	1070
250-330/5504	250M	63,00	86,00	1250
250-330/7504	280S	86,00	114,00	1365
250-330/9004	280M	104,00	144,00	1465
250-330/11004	315S	127,00	170,00	1600
250-330/13204	315M	152,00	225,00	1895

Etaline-R	Motor			[kg]
	Size	[kW]	460 V	
			≈[A]	
250-330/16004	315L	184,00	280,00	2095
250-400/3004	200L	34,50	47,00	1101
250-400/3704	225S	42,50	60,00	1195
250-400/4504	225M	52,00	70,00	1235
250-400/5504	250M	63,00	86,00	1410
250-400/7504	280S	86,00	114,00	1525
250-400/9004	280M	104,00	144,00	1625
250-400/11004	315S	127,00	170,00	1760
250-400/13204	315M	152,00	225,00	2055
250-400/16004	315L	192,00	280,00	2255
250-400/20004	315L	230,00	335,00	2295
250-400/25004	315	300,00	434,00	2250
300-360/3704	225S	42,50	60,00	1465
300-360/4504	225M	52,00	70,00	1505
300-360/5504	250M	63,00	86,00	1680
300-360/7504	280S	86,00	114,00	1795
300-360/9004	280M	104,00	144,00	1895
300-360/11004	315S	127,00	170,00	2030
300-360/13204	315M	152,00	225,00	2325
300-360/16004	315L	192,00	280,00	2525
300-360/20004	315L	230,00	335,00	2565
300-400/5504	250M	63,00	86,00	1645
300-400/7504	280S	86,00	114,00	1760
300-400/9004	280M	104,00	144,00	1860
300-400/11004	315S	127,00	170,00	1995
300-400/13204	315M	152,00	225,00	2290
300-400/16004	315L	192,00	280,00	2490
300-400/20004	315L	230,00	335,00	2530
300-400/25004	315	300,00	436,00	2475
300-400/31504	315	378,00	554,00	2685
350-340/2204	180L	25,30	36,50	1171
350-340/3004	200L	34,50	47,00	1221
350-340/3704	225S	42,50	60,00	1315
350-340/4504	225M	52,00	70,00	1355
350-340/5504	250M	63,00	86,00	1530
350-340/7504	280S	86,00	114,00	1645
350-340/9004	280M	104,00	144,00	1745
350-340/11004	315S	127,00	170,00	1880
350-340/13204	315M	152,00	225,00	2175

Selection charts

Etaline-R, n = 1450 rpm (fixed speed version)

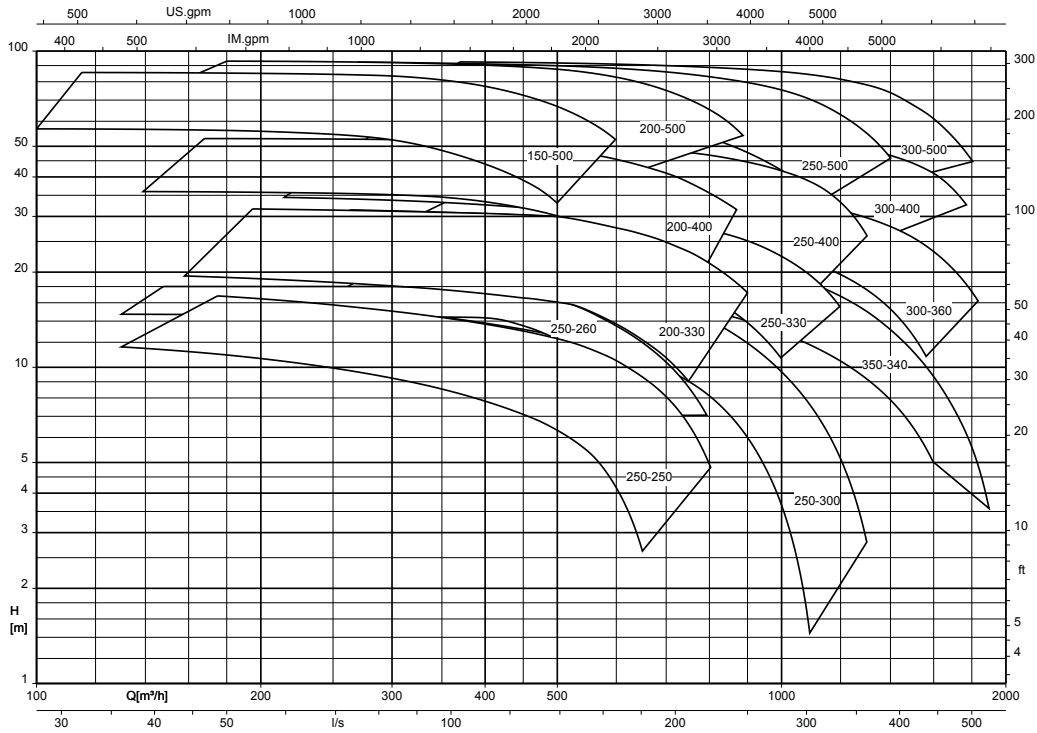

Etaline / Etaline-R (fixed speed version), n = 1750 rpm

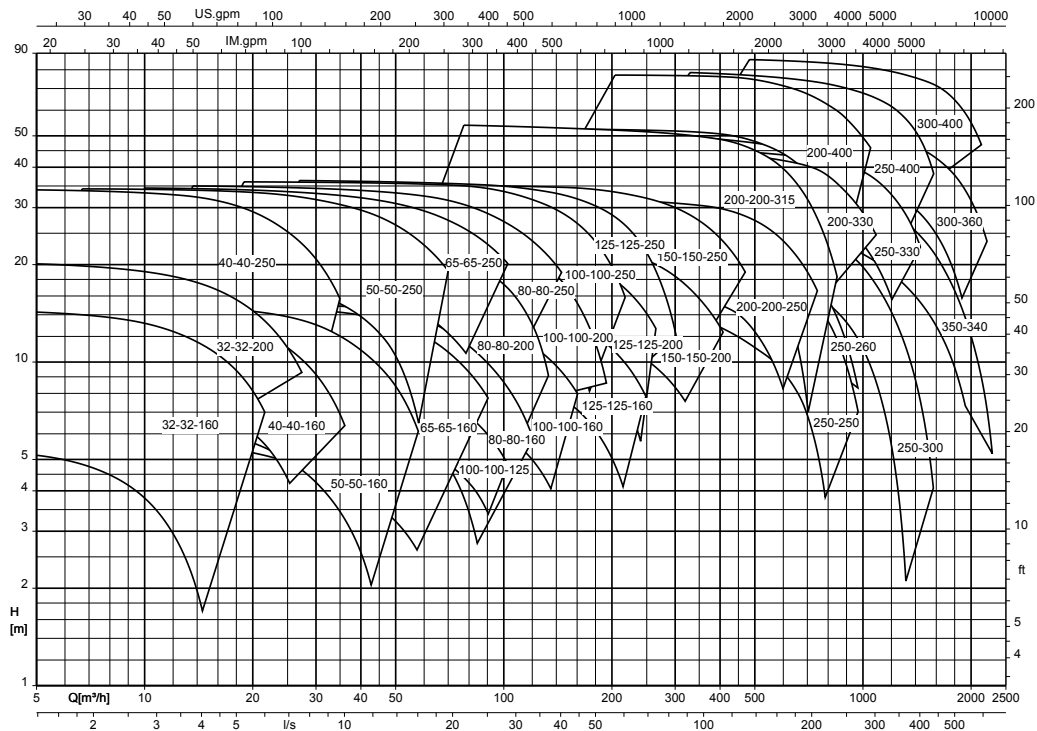

Characteristic curves

General

Test class

Characteristic curves to ISO 9906 Class 3B

NPSH values

The NPSH values indicated in the characteristic curves correspond to a head drop of 3 %.

NPSH values in part-load conditions

NPSH values for flow rates below $Q = 0.3 \times Q_{\text{opt}}$ can only be measured with intense technical efforts. Evidence of NPSH values in the part-load range cannot be provided.

Density of the fluid handled

The indicated heads and performance data apply to pumped fluids with a density $\rho = 1.0 \text{ kg/dm}^3$ and a kinematic viscosity of up to $20 \text{ mm}^2/\text{s}$ max. If the density $\neq 1.0$, the performance data must be multiplied by ρ . For a viscosity $> 20 \text{ mm}^2/\text{s}$ the corresponding data for cold water has to be calculated and the impact on the pump's performance has to be determined.

Correction factors

The characteristic curves apply to pumps with cast iron or bronze impellers. When using an impeller made of cast steel materials the efficiency and pump power of the corresponding pump sizes have to be multiplied by the correction factors indicated in the characteristic curves.

Etaline-R, n = 1450 rpm (fixed speed version)

Etaline-R 150-500, n = 1450 rpm

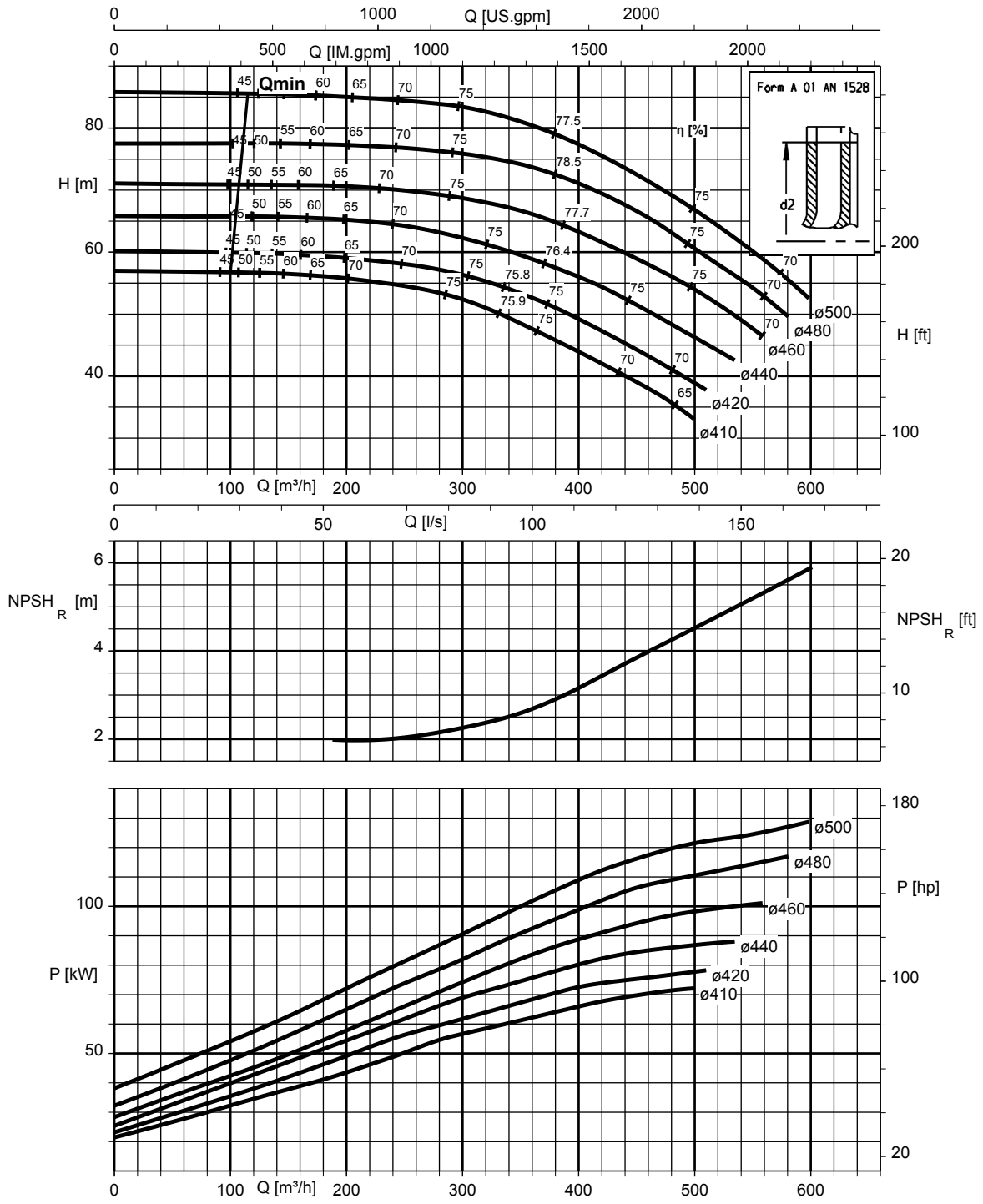

K34832/0

Etaline-R 200-330, n = 1450 rpm

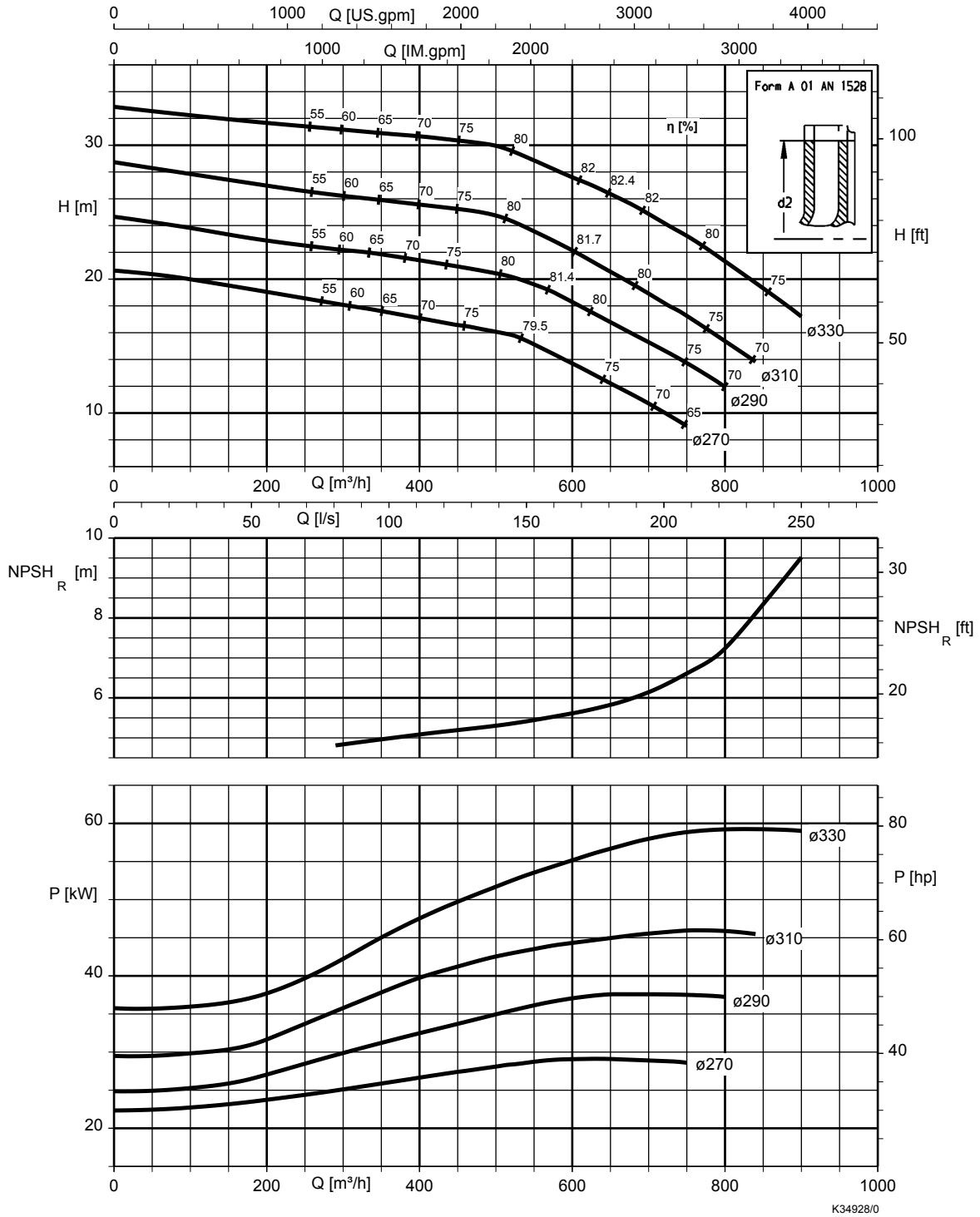

Etaline-R 200-400, n = 1450 rpm

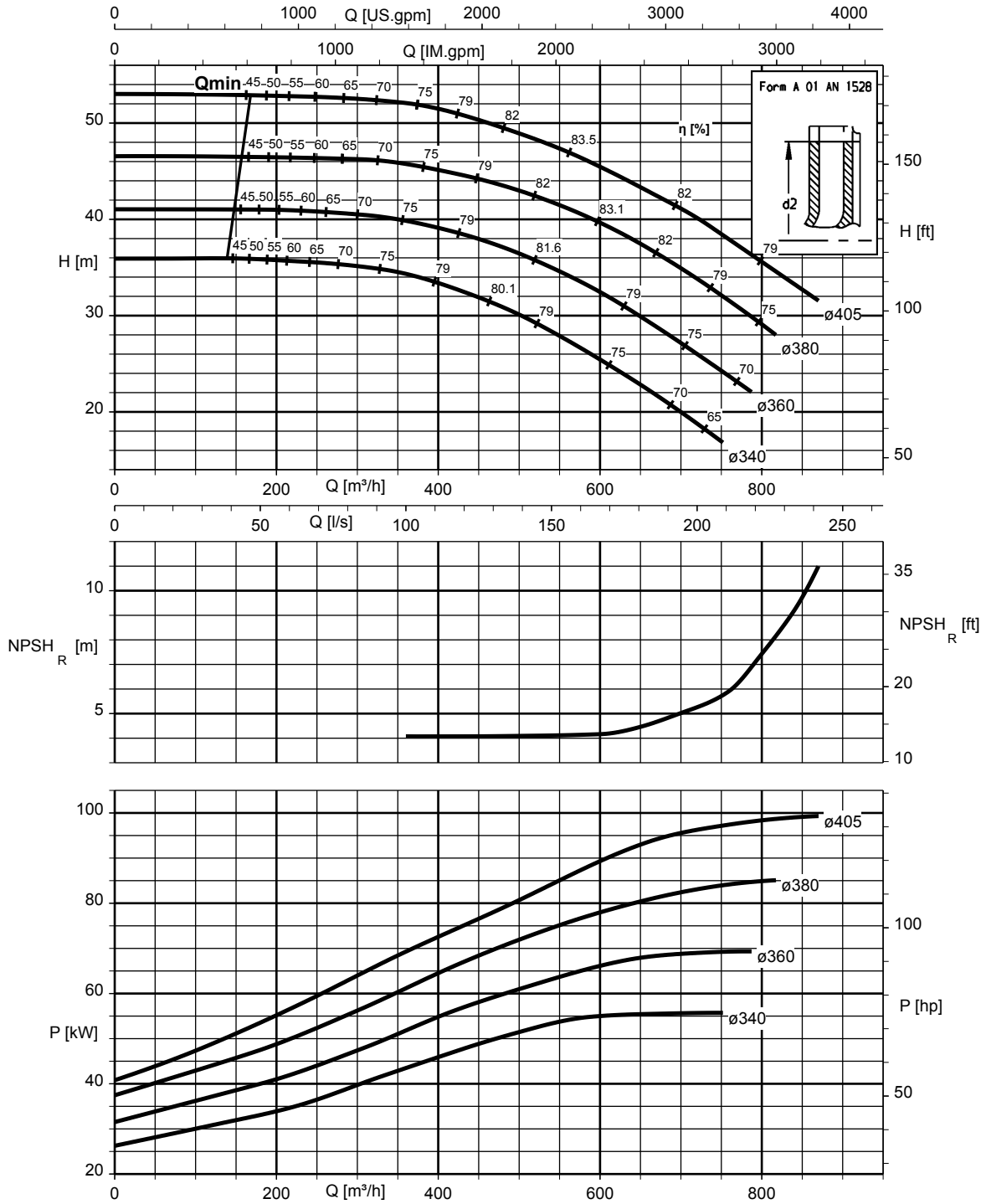

K34839/0

Etaline-R 200-500, n = 1450 rpm

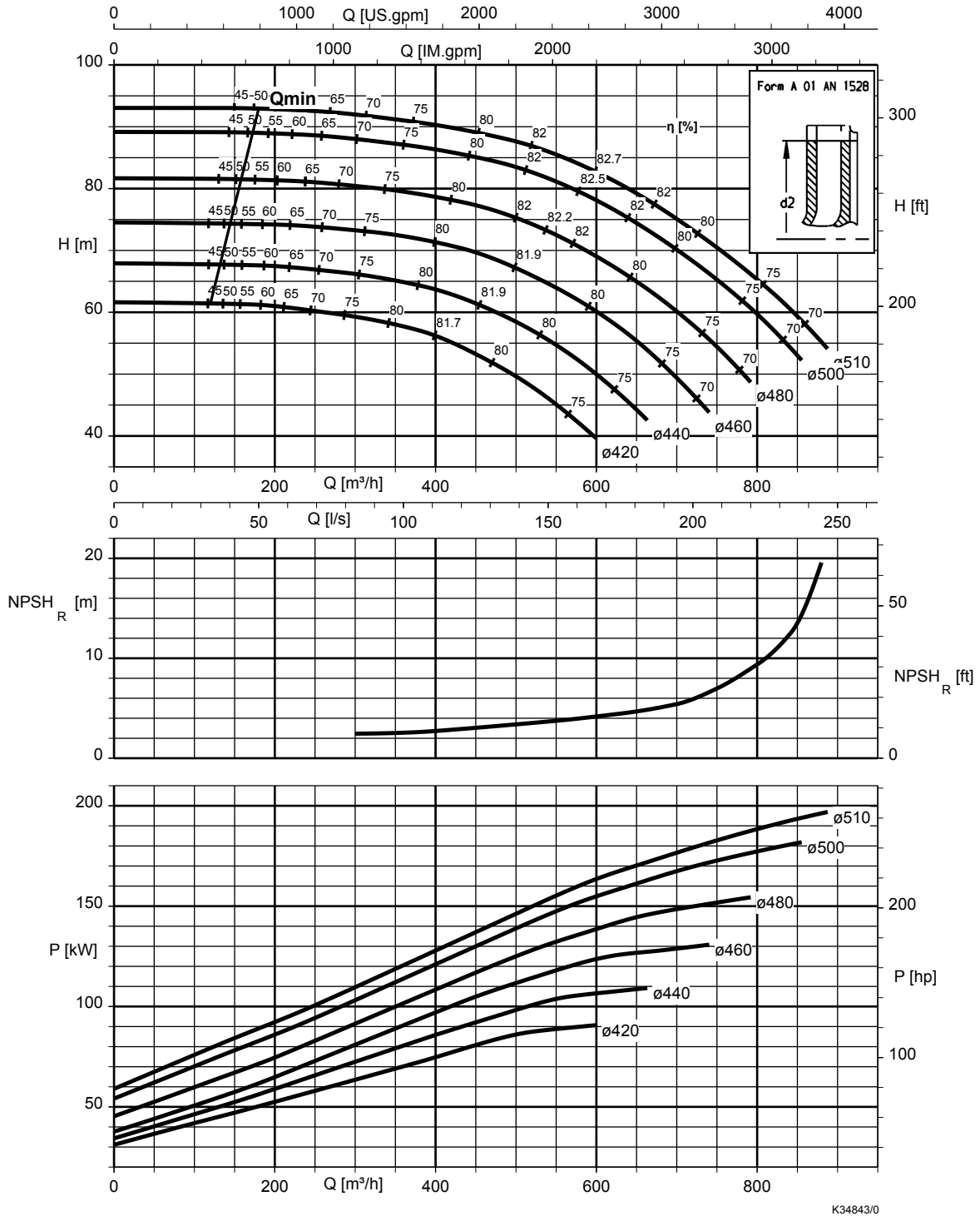

Etaline-R 250-250, n = 1450 rpm

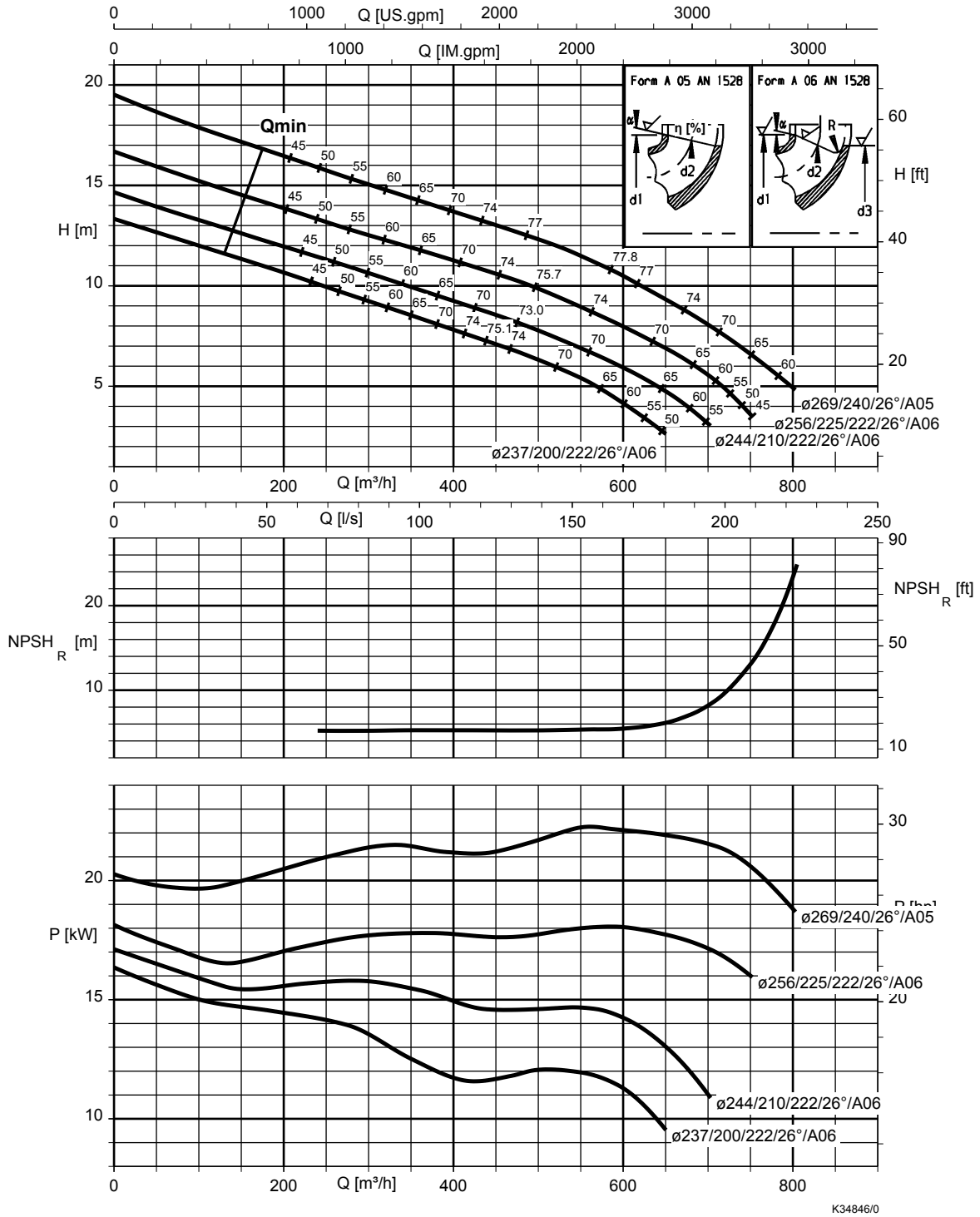

Etaline-R 250-260, n = 1450 rpm

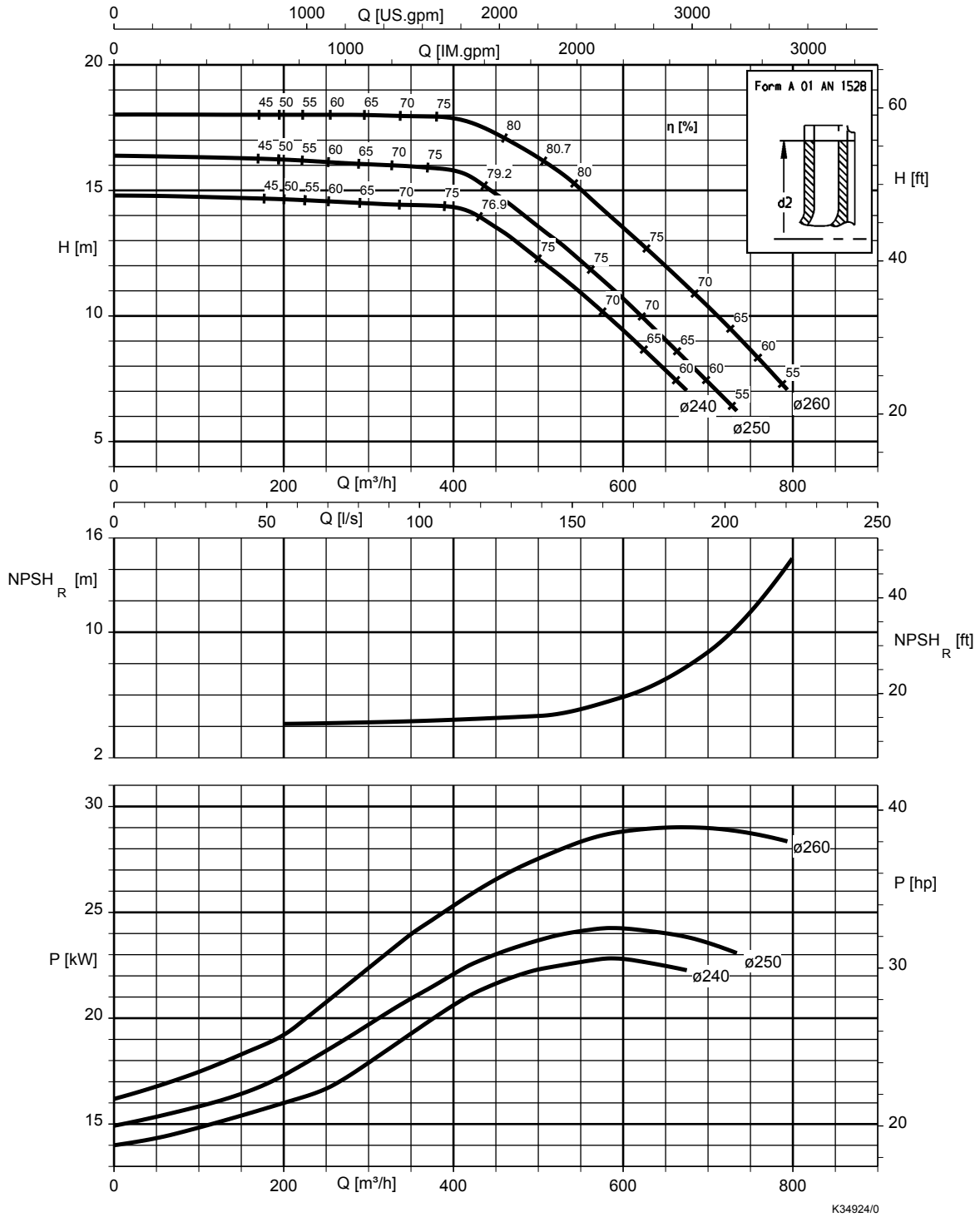

Etaline-R 250-300, n = 1450 rpm

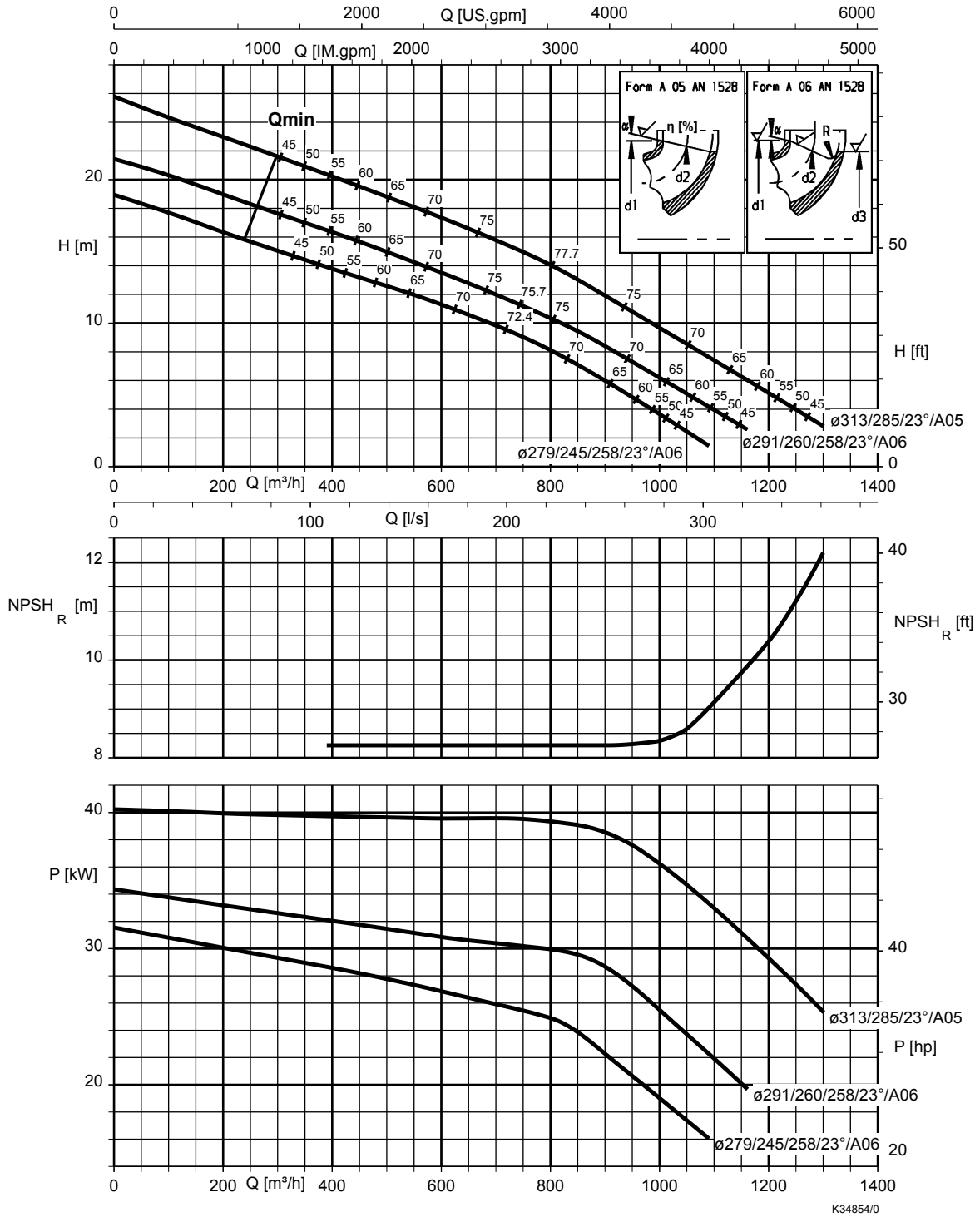

Etaline-R 250-330, n = 1450 rpm

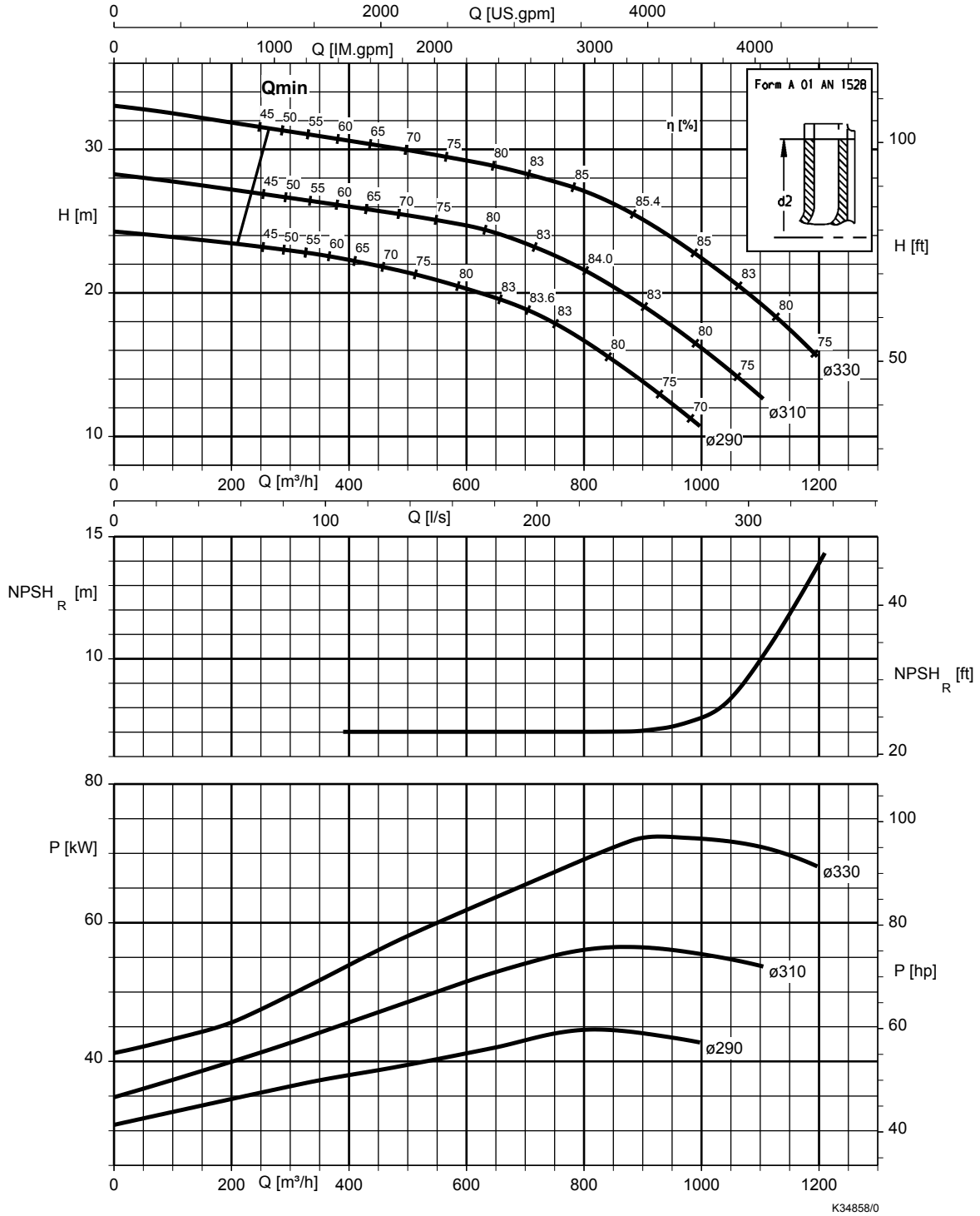

Etaline-R 250-400, n = 1450 rpm

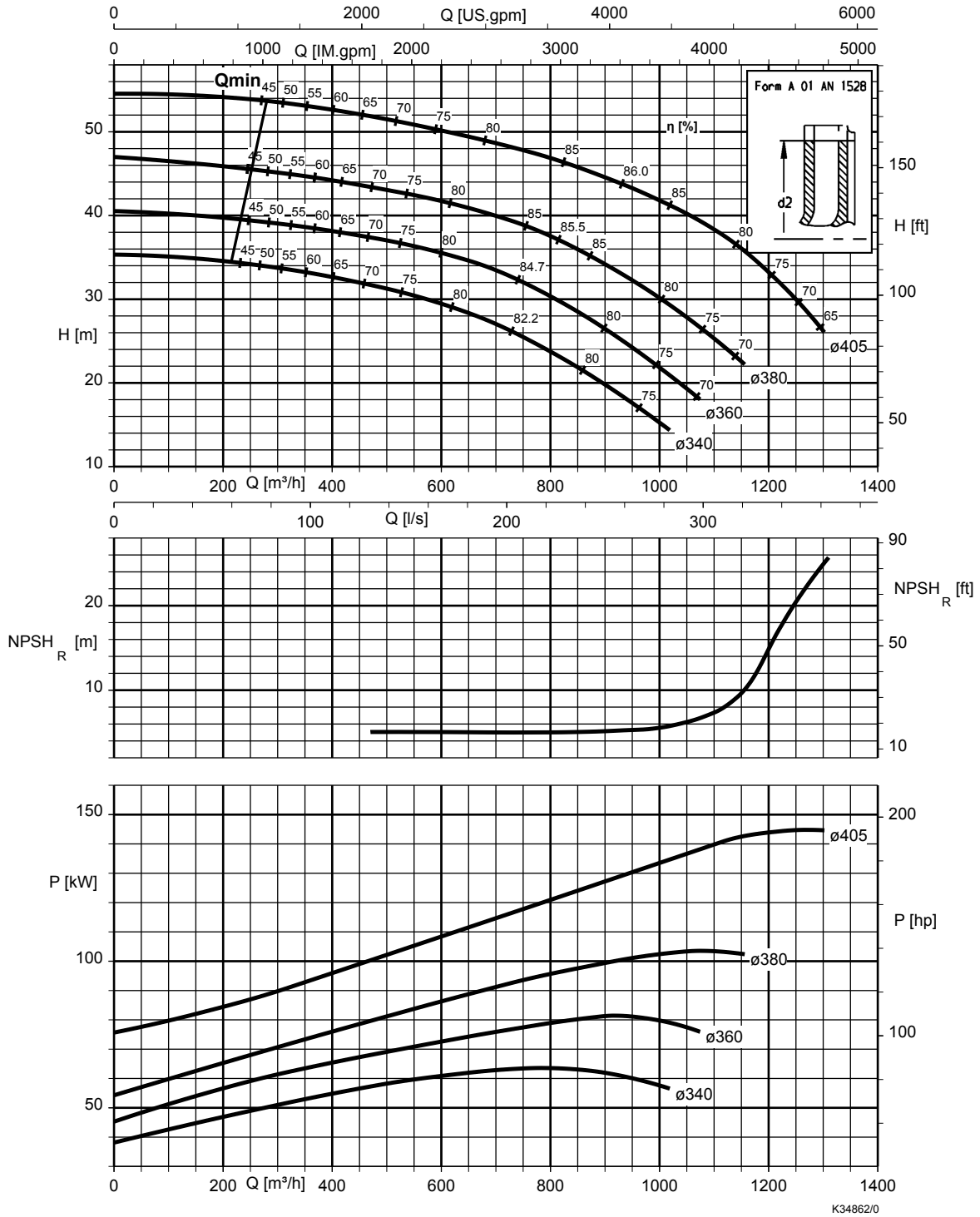

Etaline-R 250-500, n = 1450 rpm

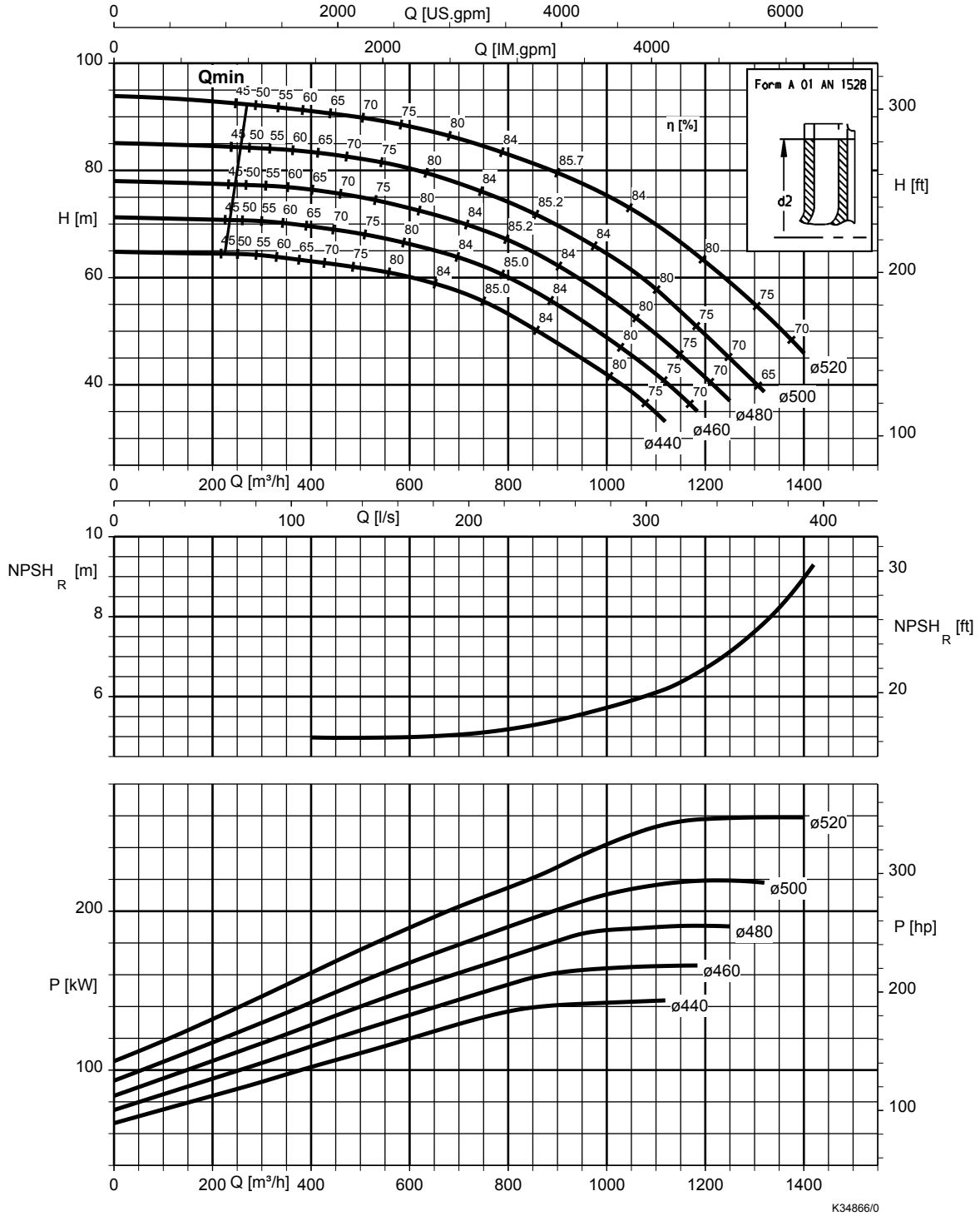

Etaline-R 300-360, n = 1450 rpm

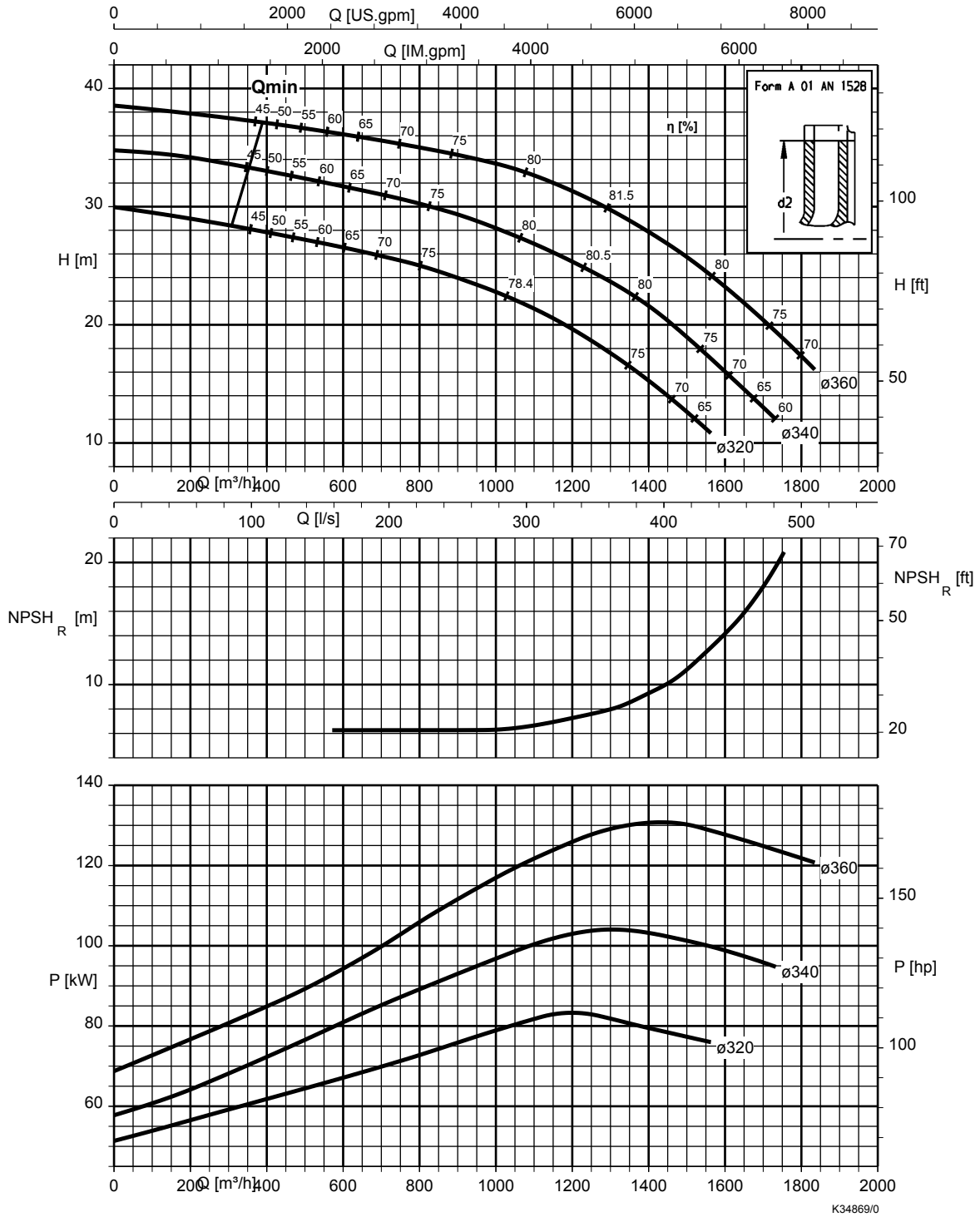

Etaline-R 300-400, n = 1450 rpm

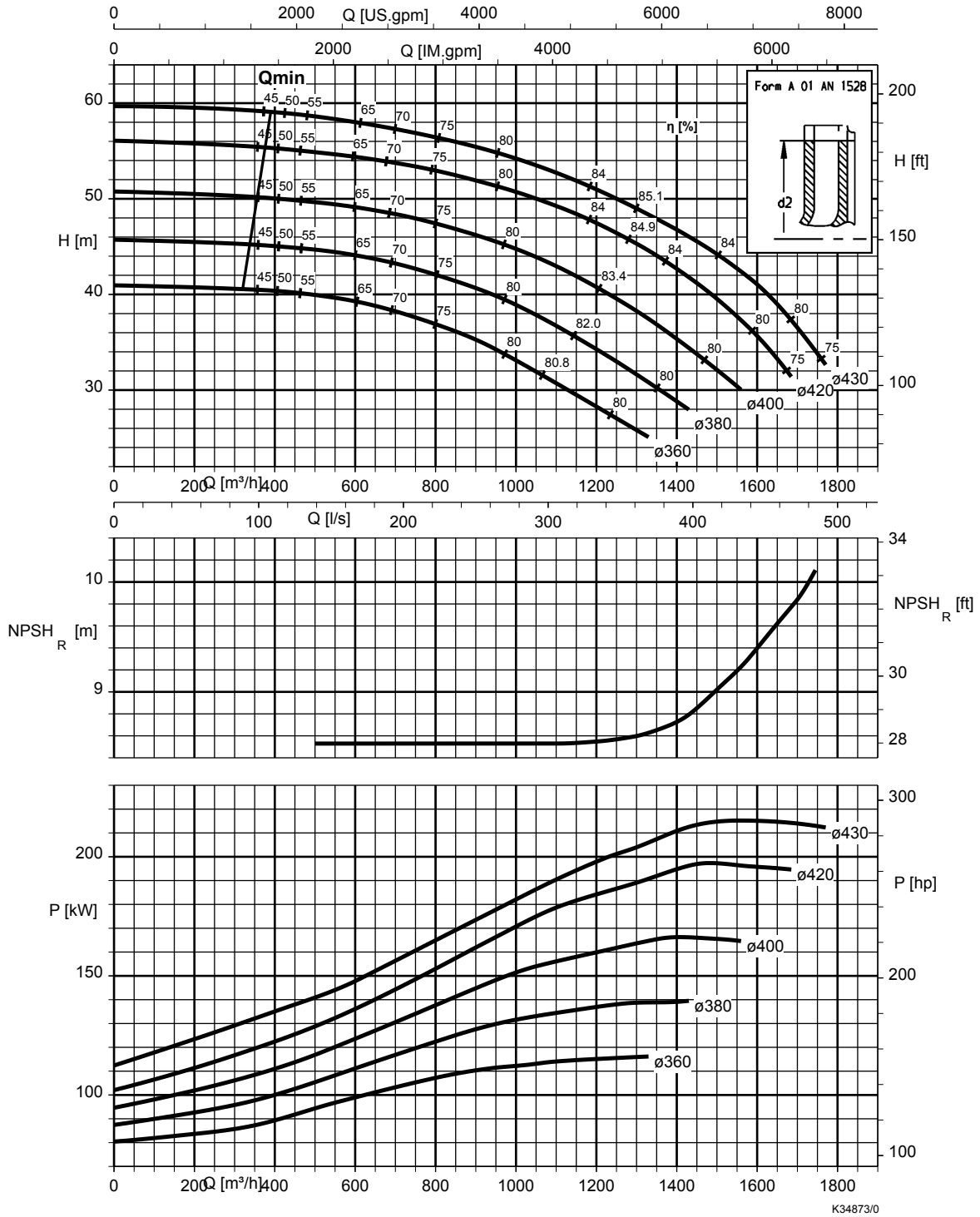

Etaline-R 300-500, n = 1450 rpm

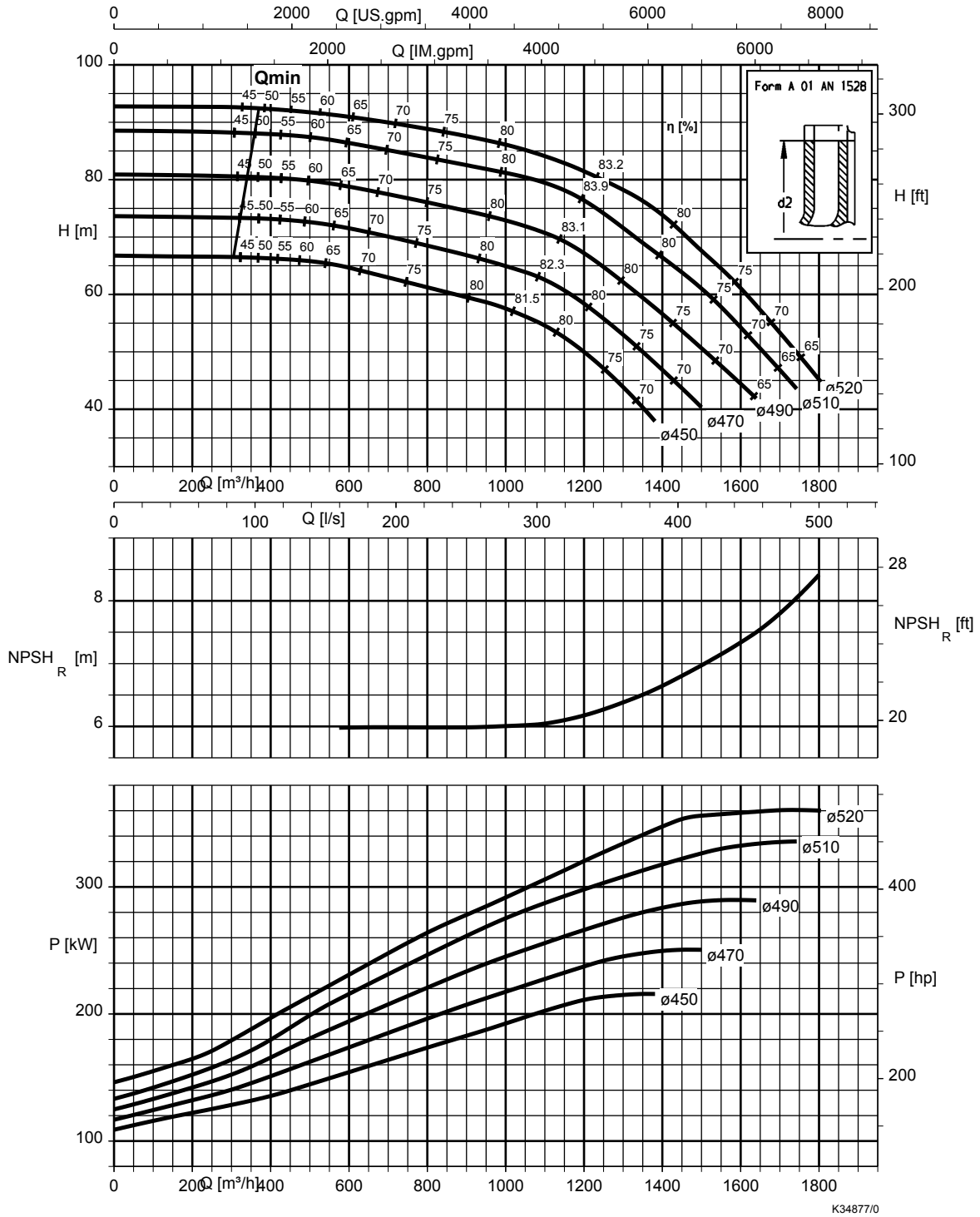

Etaline-R 350-340, n = 1450 rpm

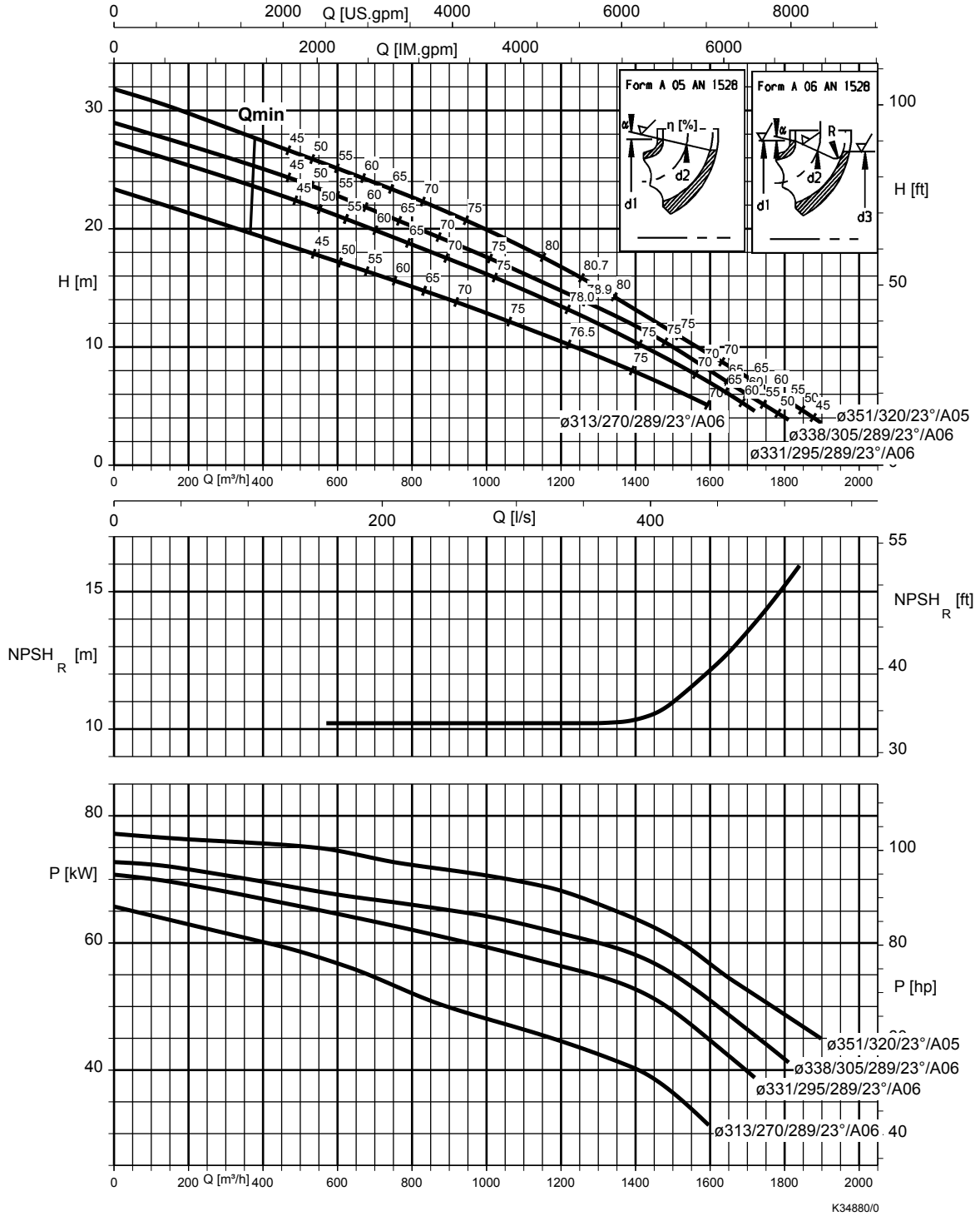

Etaline-R, n = 1750 rpm (fixed speed version)

Etaline-R 200-330, n = 1750 rpm

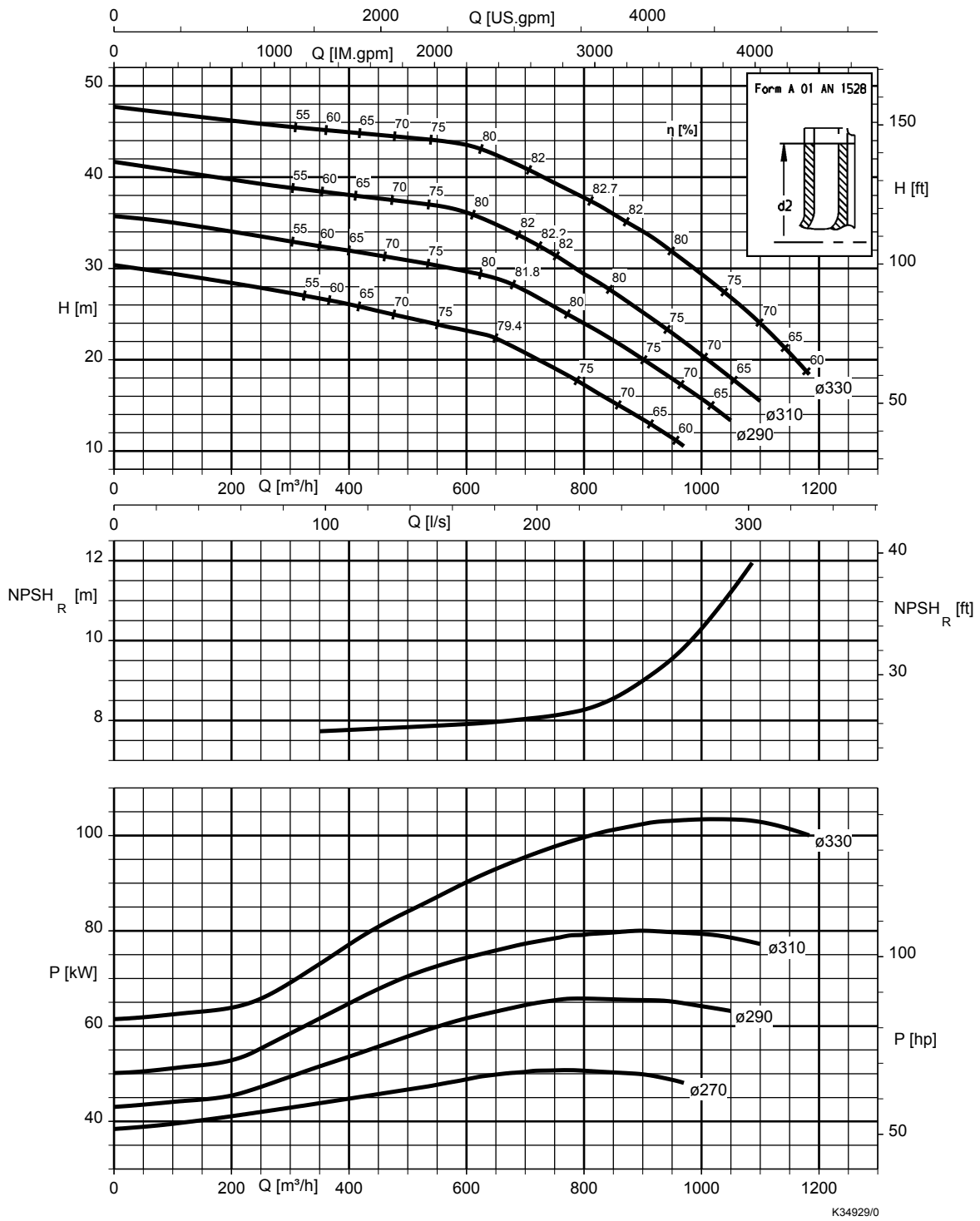

Etaline-R 200-400, n = 1750 rpm

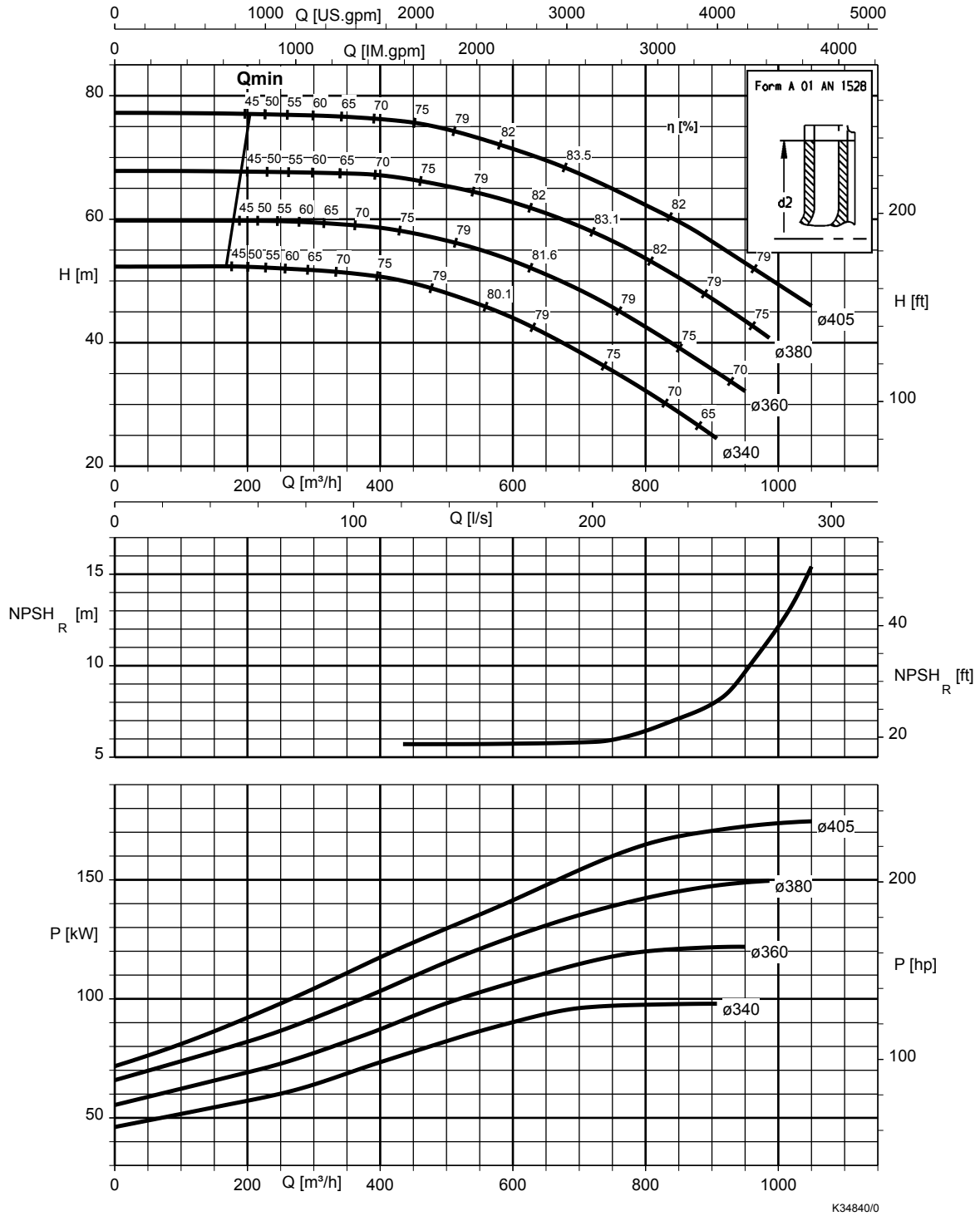

Etaline-R 250-250, n = 1750 rpm

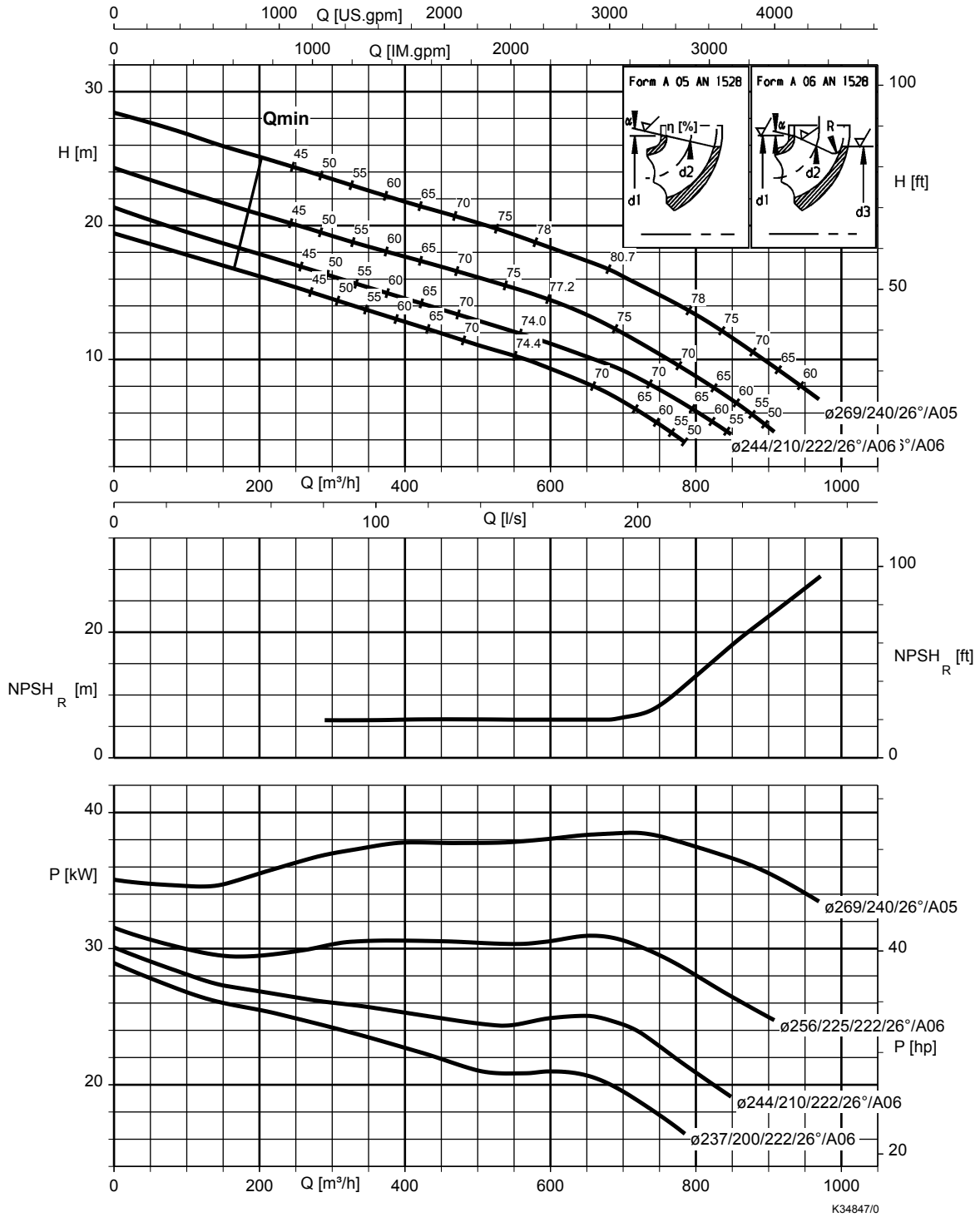

Etaline-R 250-260, n = 1750 rpm

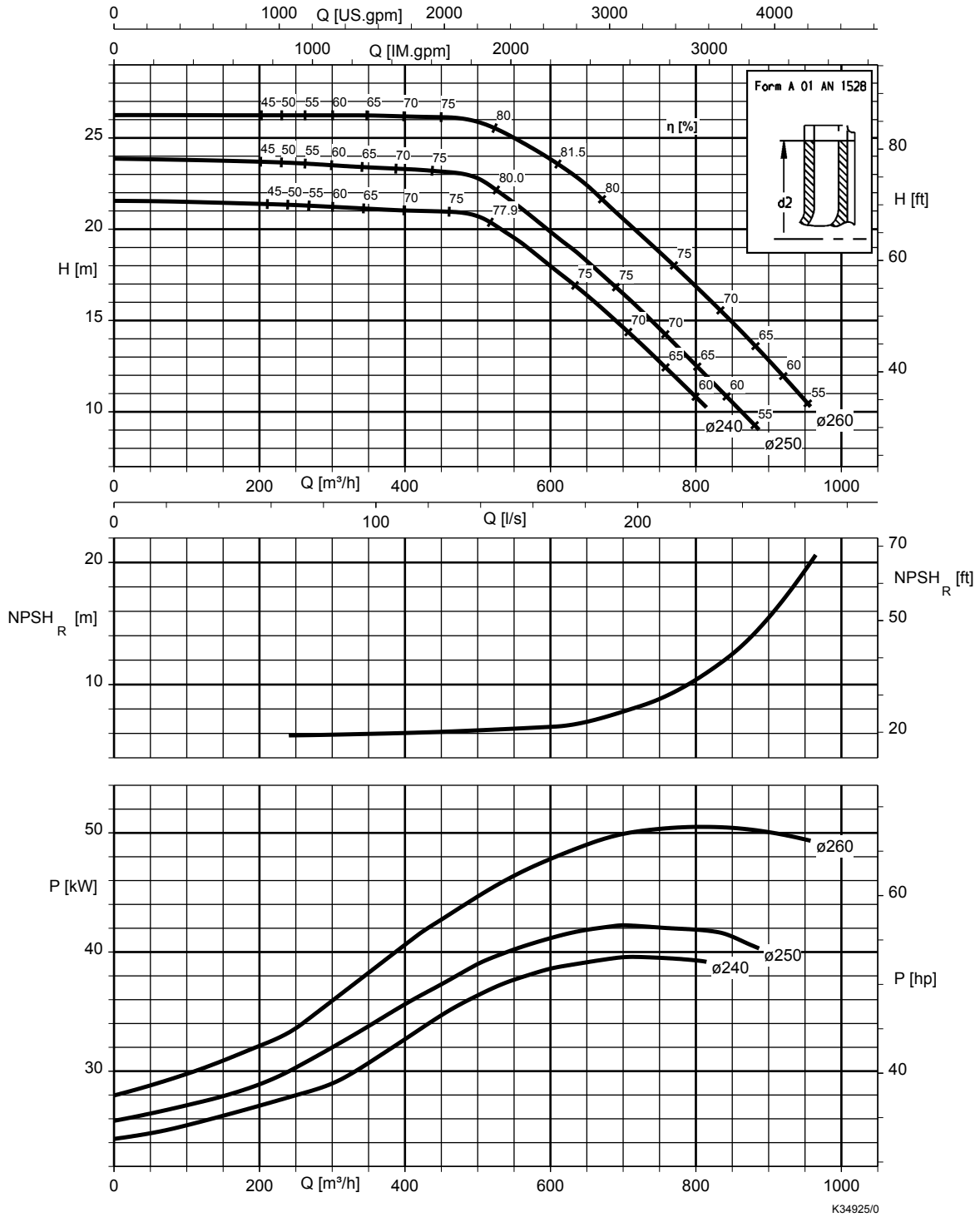

Etaline-R 250-300, n = 1750 rpm

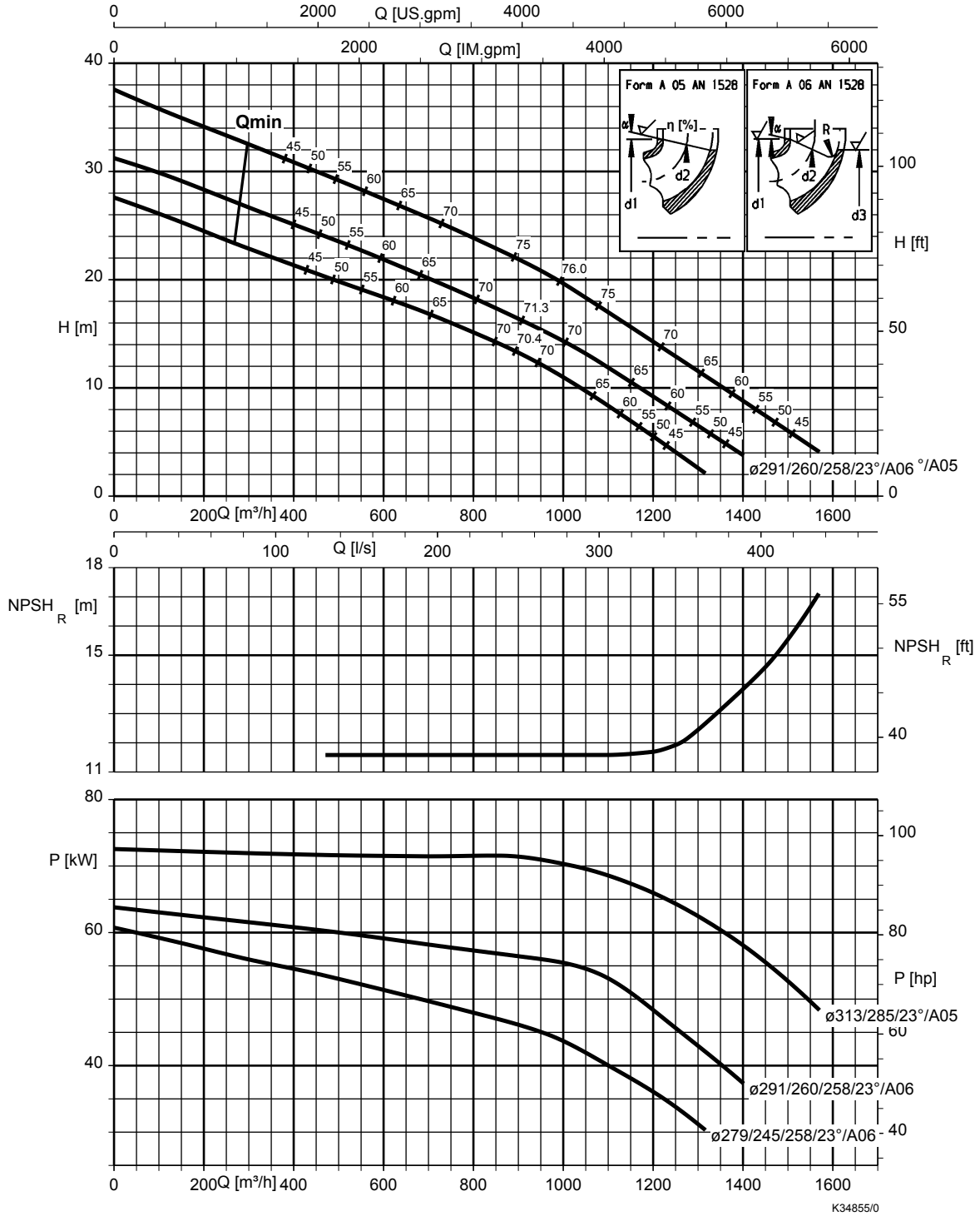

Etaline-R 250-330, n = 1750 rpm

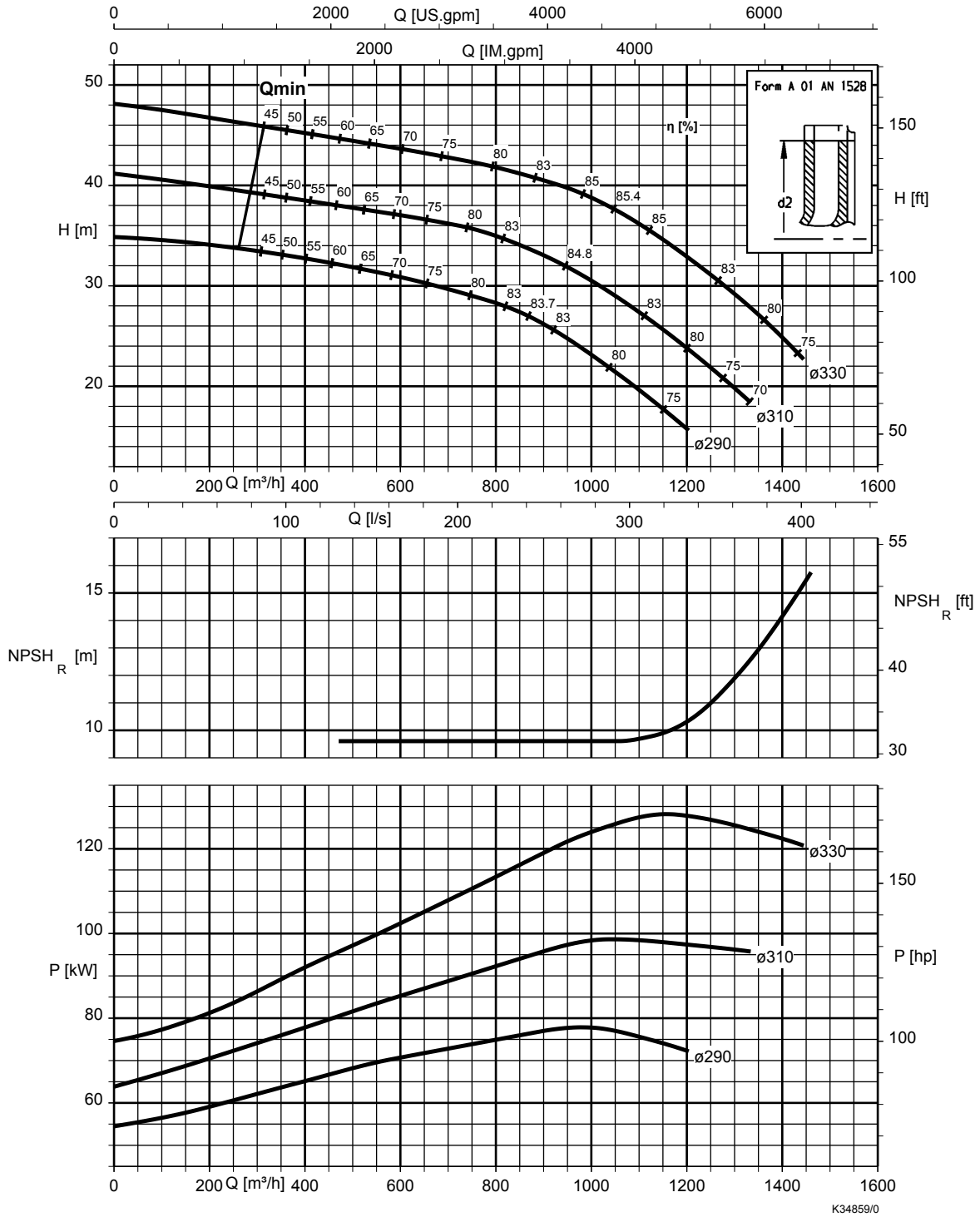

K34859/0

Etaline-R 250-400, n = 1750 rpm

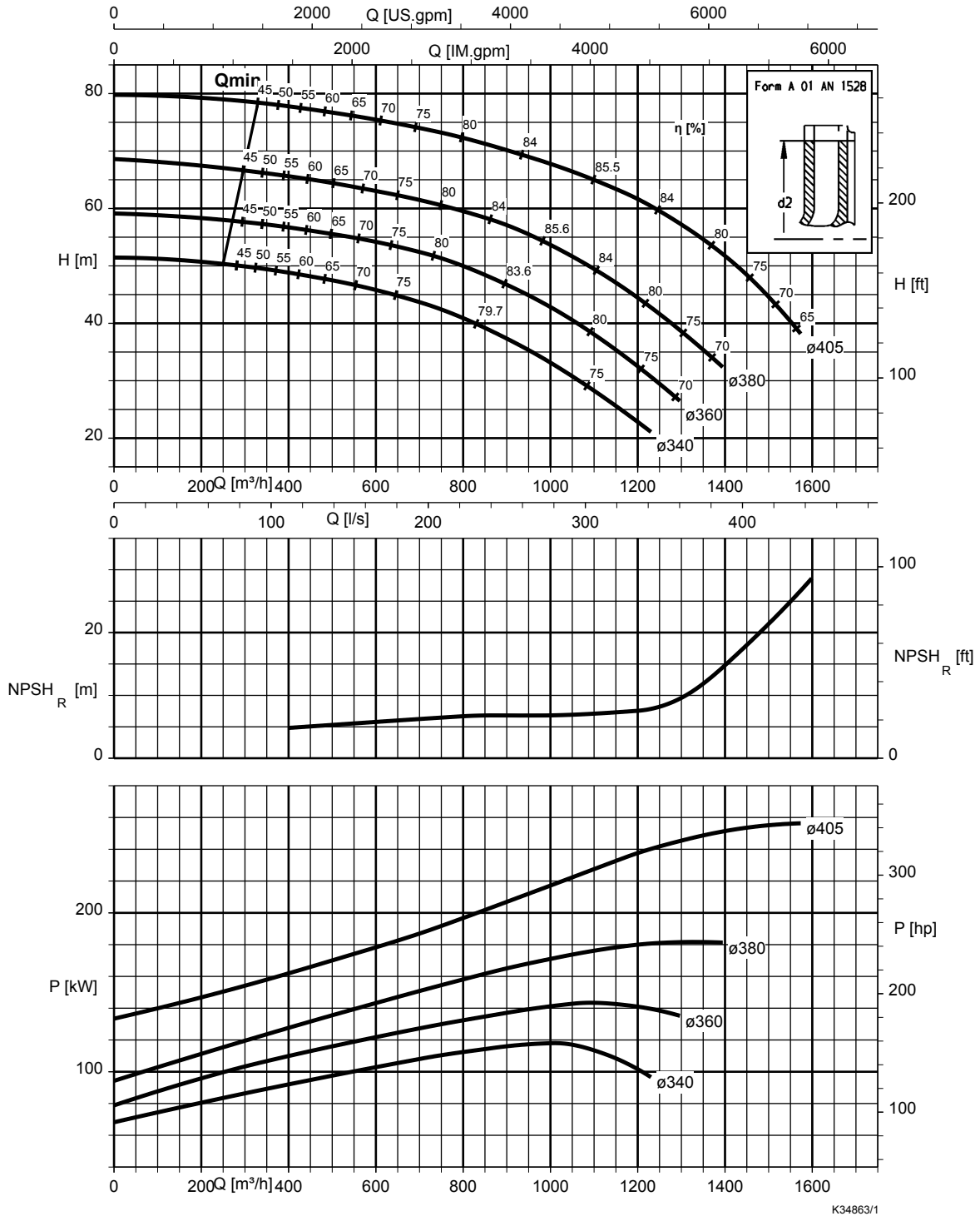

K34863/1

Etaline-R 300-360, n = 1750 rpm

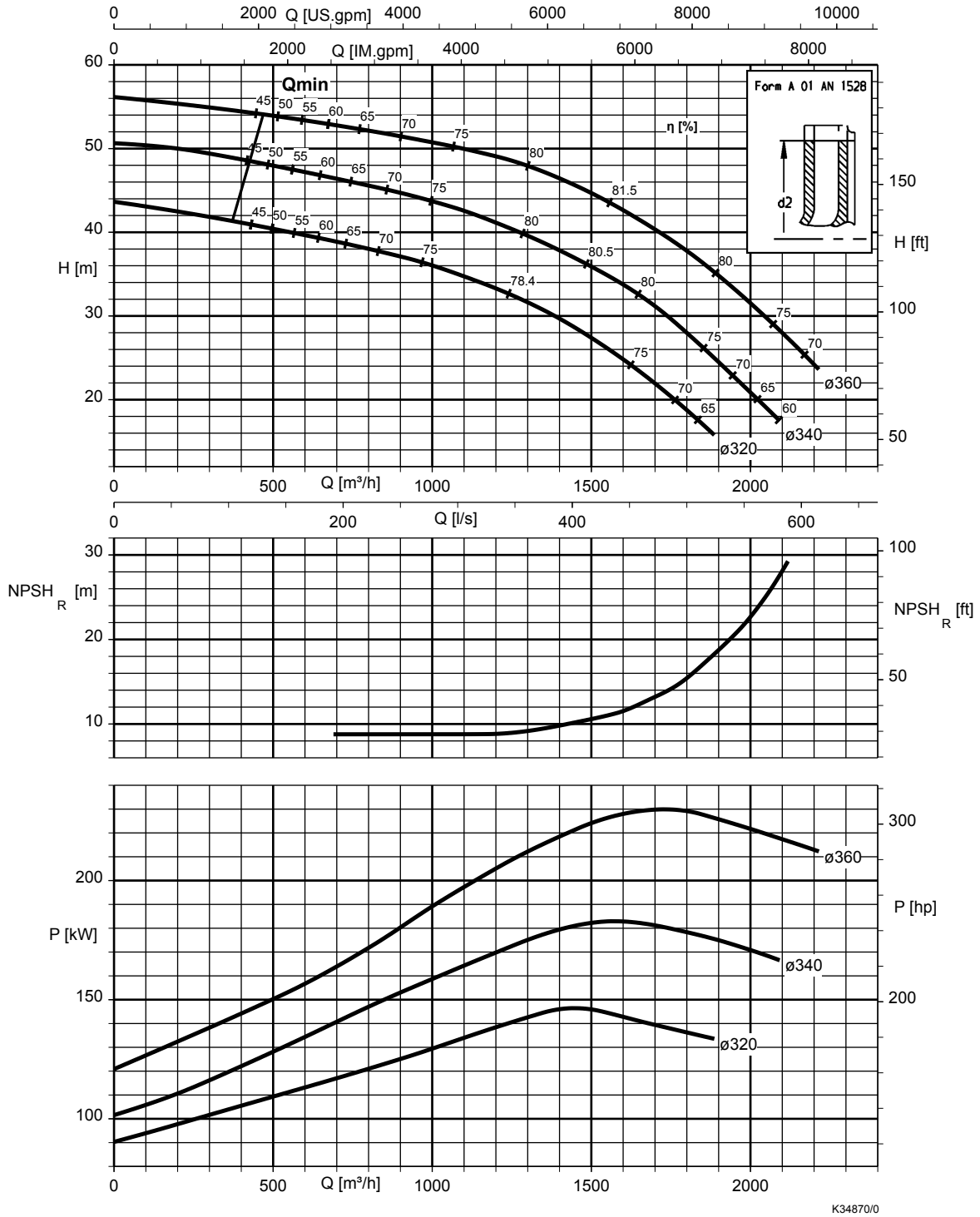

K34870/0

Etaline-R 300-400, n = 1750 rpm

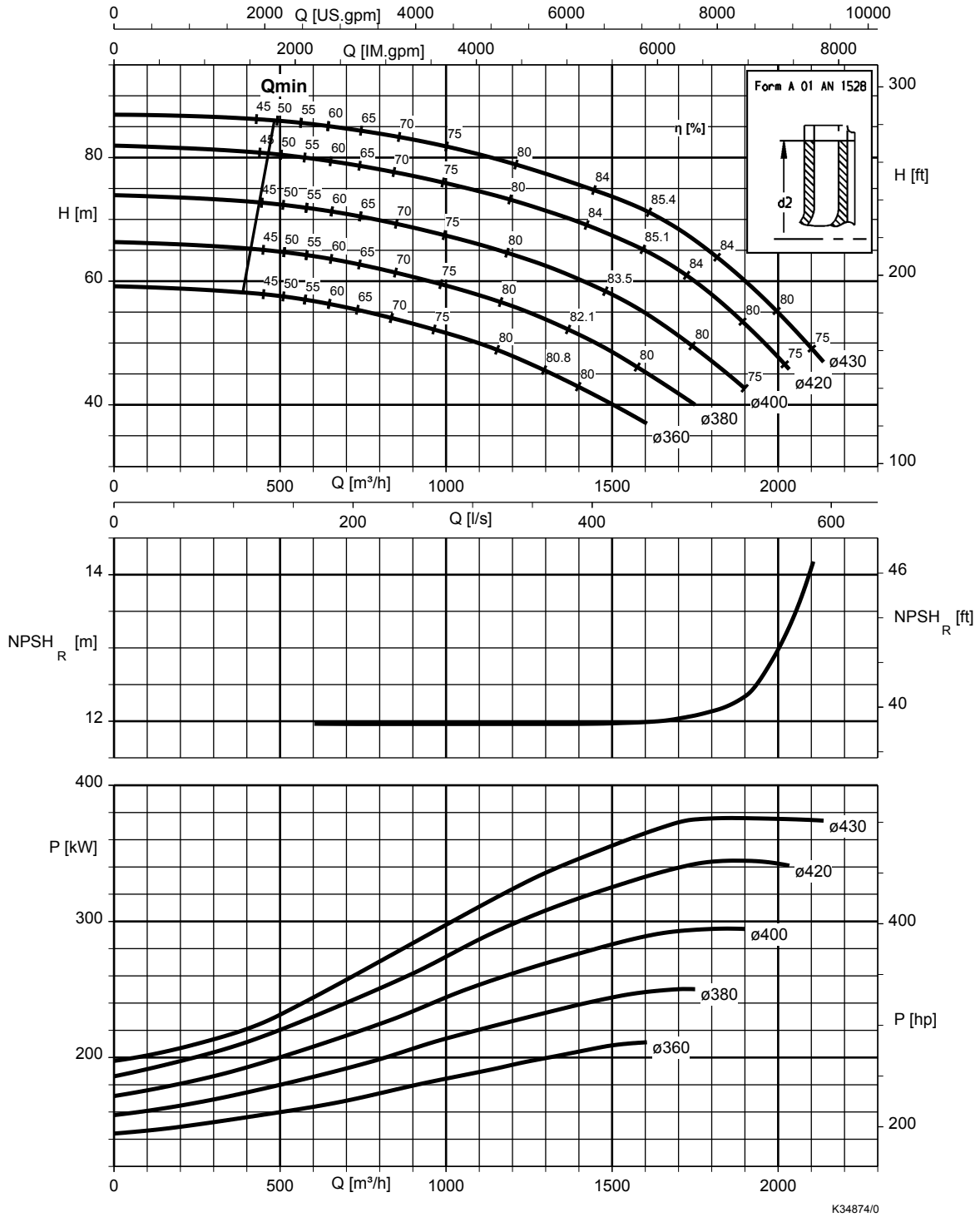

Etaline-R 350-340, n = 1750 rpm

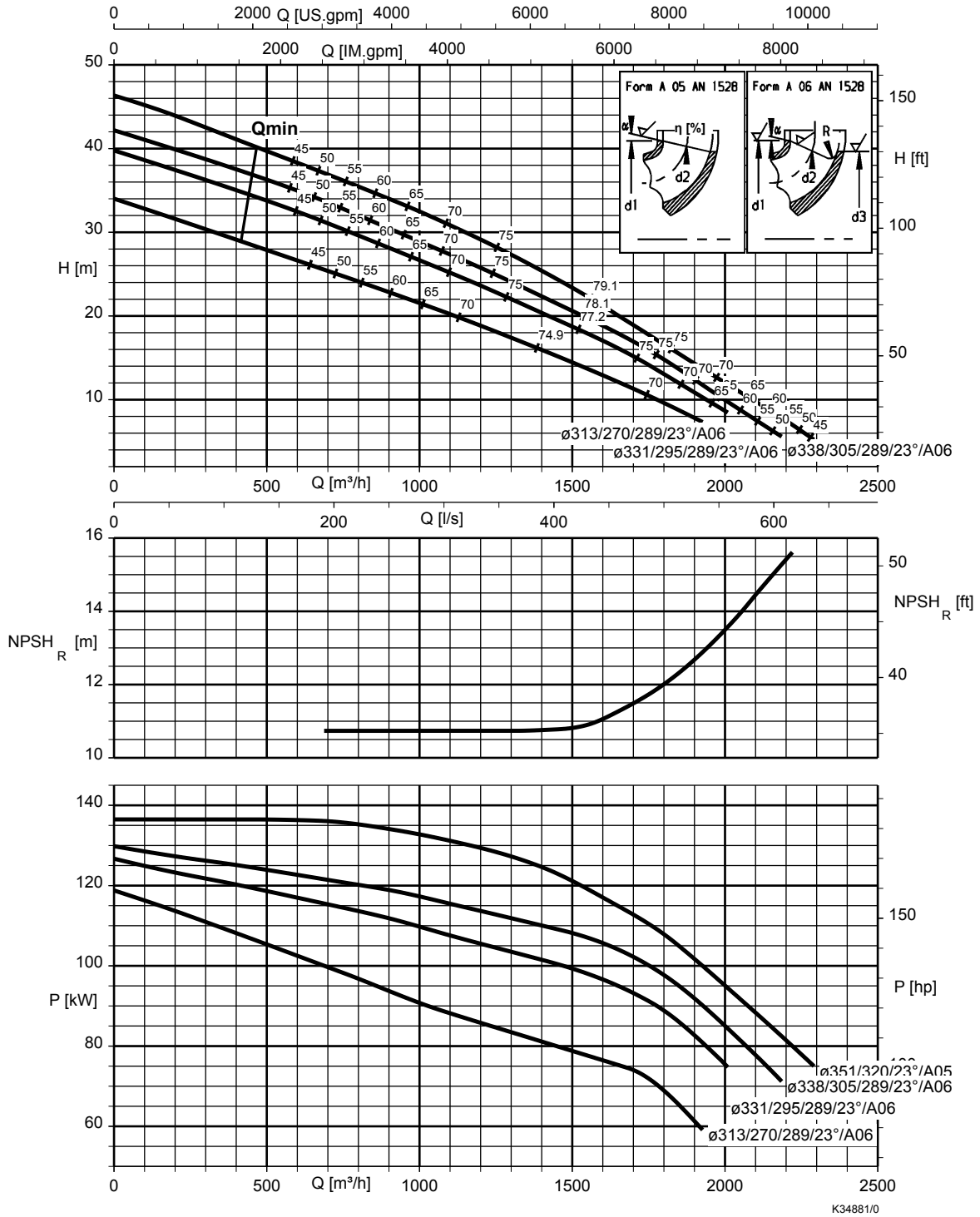

K34881/0

Etaline-R	DN ₁ ⁽¹⁾	DN ₂ ⁽¹⁾	a	b ₁	b ₂	b ₃	d ₂	d ₃	e	h ₁	h ₂	h ₃	h ₄	h ₅	h ₆	k ₁	k ₂	k ₃	l ₁	l ₂	m ₁	m ₂	n ₁	n ₂	p	w	x	β
150-500/13204	200	150	280	315	350	955	660	610	180	650	450	710	510	207	1520	90	86	75	1637	1357	320	260	250	190	495	425	200	50
150-500/16004	200	150	280	315	350	955	660	610	180	650	450	710	510	207	1520	90	86	75	1797	1517	320	260	250	190	495	425	200	50
200-330/1504	250	200	310	295	333	955	450	320	213	650	300	710	360	225	1370	85	82	105	1180	870	375	320	310	250	197	352	200	40
200-330/1854	250	200	310	295	333	955	450	363	213	650	300	710	360	225	1370	85	82	105	1264	954	375	320	310	250	262	352	200	40
200-330/2204	250	200	310	295	333	955	450	363	213	650	300	710	360	225	1370	85	82	105	1264	954	375	320	310	250	262	352	200	40
200-330/3004	250	200	310	295	333	955	450	402	213	650	300	710	360	225	1370	85	82	105	1321	1011	375	320	310	250	300	352	200	40
200-330/3704	250	200	310	295	333	955	450	442	213	650	300	710	360	225	1370	85	82	105	1320	1010	375	320	310	250	325	361	200	40
200-330/4504	250	200	310	295	333	955	450	442	213	650	300	710	360	225	1370	85	82	105	1494	1184	375	320	310	250	325	361	200	40
200-330/5504	250	200	310	295	333	955	660	495	213	650	300	710	360	225	1370	85	82	105	1488	1178	375	320	310	250	392	418	200	40
200-330/7504	250	200	310	295	333	955	660	555	213	650	300	710	360	225	1370	85	82	105	1548	1238	375	320	310	250	432	418	200	40
200-330/9004	250	200	310	295	333	955	660	555	213	650	300	710	360	225	1370	85	82	105	1658	1348	375	320	310	250	432	418	200	40
200-330/11004	250	200	310	295	333	955	660	610	213	650	300	710	360	225	1370	85	82	105	1667	1357	375	320	310	250	495	425	200	40
200-400/3004	250	200	295	290	351	975	450	402	213	700	400	760	460	225	1520	85	82	105	1306	1011	375	320	310	250	300	352	200	50
200-400/3704	250	200	295	290	351	975	450	442	213	700	400	760	460	225	1520	85	82	105	1305	1010	375	320	310	250	325	352	200	50
200-400/4504	250	200	295	290	351	975	450	442	213	700	400	760	460	225	1520	85	82	105	1479	1184	375	320	310	250	325	361	200	50
200-400/5504	250	200	295	290	351	975	660	495	213	700	400	760	460	225	1520	85	82	105	1473	1178	375	320	310	250	392	418	200	50
200-400/7504	250	200	295	290	351	975	660	555	213	700	400	760	460	225	1520	85	82	105	1533	1238	375	320	310	250	432	418	200	50
200-400/9004	250	200	295	290	351	975	660	555	213	700	400	760	460	225	1520	85	82	105	1643	1348	375	320	310	250	432	418	200	50
200-400/11004	250	200	295	290	351	975	660	610	213	700	400	760	460	225	1520	85	82	105	1652	1357	375	320	310	250	495	425	200	50
200-400/13204	250	200	295	290	351	975	660	610	213	700	400	760	460	225	1520	85	82	105	1812	1517	375	320	310	250	495	425	200	50
200-400/16004	250	200	295	290	351	975	660	610	213	700	400	760	460	225	1520	85	82	105	1812	1517	375	320	310	250	495	425	200	50
200-400/20004	250	200	295	290	351	975	660	610	213	700	400	760	460	225	1520	85	82	105	1952	1657	375	320	310	250	495	425	200	50
200-500/4504	250	200	295	397	385	1100	450	442	213	650	450	710	510	212	1520	85	82	95	1407	1112	375	320	310	250	325	352	200	50
200-500/5504	250	200	295	397	385	1100	660	495	213	650	450	710	510	212	1520	85	82	95	1473	1178	375	320	310	250	392	361	200	62
200-500/7504	250	200	295	397	385	1100	660	555	213	650	450	710	510	212	1520	85	82	95	1533	1238	375	320	310	250	432	418	200	62
200-500/9004	250	200	295	397	385	1100	660	555	213	650	450	710	510	212	1520	85	82	95	1643	1348	375	320	310	250	432	418	200	62
200-500/1004	250	200	295	397	385	1100	660	610	213	650	450	710	510	212	1520	85	82	95	1652	1357	375	320	310	250	495	425	200	62
200-500/13204	250	200	295	397	385	1100	660	610	213	650	450	710	510	212	1520	85	82	95	1812	1517	375	320	310	250	495	425	200	62
200-500/16004	250	200	295	397	385	1100	660	610	213	650	450	710	510	212	1520	85	82	95	1812	1517	375	320	310	250	495	425	200	62
200-500/20004	250	200	295	397	385	1100	660	610	213	650	450	710	510	212	1520	85	82	95	1952	1657	375	320	310	250	495	425	200	62
200-500/25004	250	200	295	397	385	1100	800	610	213	650	450	710	510	212	1520	85	82	95	2041	1746	375	320	310	250	495	454	200	62
250-250/754	250	250	320	265	322	910	450	267	203	555	345	615	405	215	1320	85	85	105	1166	846	375	375	310	310	167	435	200	40
250-250/1104	250	250	320	265	322	910	450	320	203	555	345	615	405	215	1320	85	85	105	1233	913	375	375	310	310	167	435	200	40
250-250/1504	250	250	320	265	322	910	450	320	203	555	345	615	405	215	1320	85	85	105	1275	955	375	375	310	310	197	437	200	40
250-250/1854	250	250	320	265	322	910	450	363	203	555	345	615	405	215	1320	85	85	105	1359	1039	375	375	310	310	262	437	200	40
250-250/2204	250	250	320	265	322	910	450	363	203	555	345	615	405	215	1320	85	85	105	1359	1039	375	375	310	310	300	437	200	40
250-250/3004	250	250	320	265	322	910	450	402	203	555	345	615	405	215	1320	85	85	105	1416	1096	375	375	310	310	300	437	200	40
250-250/3704	250	250	320	265	322	910	450	442	203	555	345	615	405	215	1320	85	85	105	1406	1086	375	375	310	310	325	437	200	40
250-250/4504	250	250	320	265	322	910	450	442	203	555	345	615	405	215	1320	85	85	105	1589	1269	375	375	310	310	325	446	200	40
250-260/1104	250	250	320	300	335	955	450	320	203	580	350	640	410	200	1350	85	85	90	1150	830	375	375	310	310	197	352	200	49
250-260/1504	250	250	320	300	335	955	450	320	203	580	350	640	410	200	1350	85	85	90	1190	870	375	375	310	310	197	352	200	49
250-260/1854	250	250	320	300	335	955	450	363	203	580	350	640	410	200	1350	85	85	90	1274	954	375	375	310	310	262	352	200	49
250-260/2204	250	250	320	300	335	955	450	402	203	580	350	640	410	200	1350	85	85	90	1274	954	375	375	310	310	262	352	200	49
250-260/3004	250	250	320	300	335	955	450	402	203	580	350	640	410	200	1350	85	85	90	1331	1011	375	375	310	310	300	352	200	49

Etaline-R	DN ₁ ⁽¹⁾	DN ₂ ⁽¹⁾	a	b ₁	b ₂	b ₃	d ₂	d ₃	e	h ₁	h ₂	h ₃	h ₄	h ₅	h ₆	k ₁	k ₂	k ₃	l ₁	l ₂	m ₁	m ₂	n ₁	n ₂	p	w	x	β
250-260/3704	250	250	320	300	335	955	450	442	203	580	350	640	410	200	1350	85	85	90	1321	1001	375	375	310	310	325	352	200	49
250-260/4504	250	250	320	300	335	955	450	442	203	580	350	640	410	200	1350	85	85	90	1504	1184	375	375	310	310	325	361	200	49
250-260/5504	250	250	320	300	335	955	660	495	203	580	350	640	410	200	1350	85	85	90	1555	1235	375	375	310	310	392	418	200	49
250-300/1504	300	250	340	300	352	1015	450	320	243	650	450	710	510	225	1520	88	85	95	1325	985	430	375	360	310	197	467	250	50
250-300/1854	300	250	340	300	352	1015	450	363	243	650	450	710	510	225	1520	88	85	95	1409	1069	430	375	360	310	262	467	250	50
250-300/2204	300	250	340	300	352	1015	450	363	243	650	450	710	510	225	1520	88	85	95	1409	1069	430	375	360	310	262	467	250	50
250-300/3004	300	250	340	300	352	1015	450	402	243	650	450	710	510	225	1520	88	85	95	1466	1126	430	375	360	310	300	467	250	50
250-300/3704	300	250	340	300	352	1015	450	442	243	650	450	710	510	225	1520	88	85	95	1456	1116	430	375	360	310	325	467	250	50
250-300/4504	300	250	340	300	352	1015	450	442	243	650	450	710	510	225	1520	88	85	95	1639	1299	430	375	360	310	325	476	250	50
250-300/5504	300	250	340	300	352	1015	660	495	243	650	450	710	510	225	1520	88	85	95	1690	1350	430	375	360	310	392	533	250	50
250-300/7504	300	250	340	300	352	1015	660	555	243	650	450	710	510	225	1520	88	85	95	1593	1253	430	375	360	310	432	533	250	50
250-300/9004	300	250	340	300	352	1015	660	555	243	650	450	710	510	225	1520	88	85	95	1803	1463	430	375	360	310	432	533	250	50
250-330/220	300	250	385	325	355	1050	450	363	243	600	350	660	410	225	1370	88	85	95	1339	954	430	380	360	310	262	352	200	53
250-330/300	300	250	385	325	355	1050	450	402	243	600	350	660	410	225	1370	88	85	95	1396	1011	430	380	360	310	300	352	200	53
250-330/370	300	250	385	325	355	1050	450	442	243	600	350	660	410	225	1370	88	85	95	1386	1001	430	380	360	310	325	352	200	53
250-330/450	300	250	385	325	355	1050	450	442	243	600	350	660	410	225	1370	88	85	95	1569	1184	430	380	360	310	325	361	200	53
250-330/550	300	250	385	325	355	1050	660	495	243	600	350	660	410	225	1370	88	85	95	1620	1235	430	380	360	310	392	418	200	53
250-330/750	300	250	385	325	355	1050	660	555	243	600	350	660	410	225	1370	88	85	95	1623	1238	430	380	360	310	432	418	200	53
250-330/900	300	250	385	325	355	1050	660	555	243	600	350	660	410	225	1370	88	85	95	1733	1348	430	380	360	310	432	418	200	53
250-330/1100	300	250	385	325	355	1050	660	610	243	600	350	660	410	225	1370	88	85	95	1742	1357	430	380	360	310	495	425	200	53
250-330/13204	300	250	385	325	355	1050	660	610	243	600	350	660	410	225	1370	88	85	95	1902	1517	430	380	360	310	495	425	200	53
250-330/16004	300	250	385	325	355	1050	660	610	243	600	350	660	410	225	1370	88	85	95	1902	1517	430	380	360	310	495	425	200	53
250-400/3004	300	250	355	325	376	1065	450	402	243	750	450	810	510	255	1620	88	85	105	1410	1055	430	380	360	310	300	352	200	50
250-400/370	300	250	355	325	376	1065	450	442	243	750	450	810	510	255	1620	88	85	105	1386	1031	430	380	360	310	325	352	200	50
250-400/4504	300	250	355	325	376	1065	450	442	243	750	450	810	510	255	1620	88	85	105	1476	1121	430	380	360	310	325	361	200	50
250-400/5504	300	250	355	325	376	1065	660	555	243	750	450	810	510	255	1620	88	85	105	1590	1235	430	380	360	310	392	418	200	50
250-400/7504	300	250	355	325	376	1065	660	555	243	750	450	810	510	255	1620	88	85	105	1593	1238	430	380	360	310	432	418	200	50
250-400/9004	300	250	355	325	376	1065	660	555	243	750	450	810	510	255	1620	88	85	105	1703	1348	430	380	360	310	432	418	200	50
250-400/11004	300	250	355	325	376	1065	660	610	243	750	450	810	510	255	1620	88	85	105	1712	1357	430	380	360	310	495	425	200	50
250-400/13204	300	250	355	325	376	1065	660	610	243	750	450	810	510	255	1620	88	85	105	1872	1517	430	380	360	310	495	425	200	50
250-400/16004	300	250	355	325	376	1065	660	610	243	750	450	810	510	255	1620	88	85	105	1872	1517	430	380	360	310	495	425	200	50
250-400/20004	300	250	355	325	376	1065	660	610	243	750	450	810	510	255	1620	88	85	105	2012	1657	430	380	360	310	495	425	200	50
250-400/25004	300	250	355	325	376	1065	800	610	243	750	450	810	510	255	1620	88	85	105	2101	1746	430	380	360	310	495	454	200	50
250-500/7504	300	250	360	425	443	1160	660	555	243	800	500	860	560	230	1720	88	85	95	1598	1238	430	375	360	310	432	418	200	55
250-500/9004	300	250	360	425	443	1160	660	555	243	800	500	860	560	230	1720	88	85	95	1708	1348	430	375	360	310	432	418	200	55
250-500/11004	300	250	360	425	443	1160	660	610	243	800	500	860	560	230	1720	88	85	95	1717	1357	430	375	360	310	495	425	200	55
250-500/13204	300	250	360	425	443	1160	660	610	243	800	500	860	560	230	1720	88	85	95	1877	1517	430	375	360	310	495	425	200	55
250-500/16004	300	250	360	425	443	1160	660	610	243	800	500	860	560	230	1720	88	85	95	1877	1517	430	375	360	310	495	425	200	55
250-500/20004	300	250	360	425	443	1160	660	610	243	800	500	860	560	230	1720	88	85	95	2017	1657	430	375	360	310	495	425	200	55
250-500/25004	300	250	360	425	443	1160	800	710	243	800	500	860	560	230	1720	88	85	95	2106	1746	430	375	360	310	570	454	200	55
250-500/31504	300	250	360	425	443	1160	800	710	243	800	500	860	560	230	1720	88	85	95	2190	1830	430	375	360	310	570	454	200	55
300-360/3704	300	300	435	387	458	1100	450	442	243	800	450	860	510	240	1670	88	87,5	105	1447	1012	430	430	360	360	325	363	250	45
300-360/4504	300	300	435	387	458	1100	450	442	243	800	450	860	510	240	1670	88	87,5	105	1621	1186	430	430	360	360	325	363	250	45
300-360/5504	300	300	435	387	458	1100	660	495	243	800	450	860	510	240	1670	88	87,5	105	1667	1237	430	430	360	360	392	420	250	45

Etaline-R	DN ₁ (1)	DN ₂ (1)	a	b ₁	b ₂	b ₃	d ₂	d ₃	e	h ₁	h ₂	h ₃	h ₄	h ₅	h ₆	k ₁	k ₂	k ₃	l ₁	l ₂	m ₁	m ₂	n ₁	n ₂	p	w	x	β
300-360/7504	300	300	435	387	458	1100	660	555	243	800	450	860	510	240	1670	88	87,5	105	1670	1240	430	430	360	360	432	420	250	45
300-360/9004	300	300	435	387	458	1100	660	555	243	800	450	860	510	240	1670	88	87,5	105	1780	1350	430	430	360	360	432	420	250	45
300-360/11004	300	300	435	387	458	1100	660	610	243	800	450	860	510	240	1670	88	87,5	105	1789	1359	430	430	360	360	495	427	250	45
300-360/13204	300	300	435	387	458	1100	660	610	243	800	450	860	510	240	1670	88	87,5	105	1949	1519	430	430	360	360	495	427	250	45
300-360/16004	300	300	435	387	458	1100	660	610	243	800	450	860	510	240	1670	88	87,5	105	1954	1519	430	430	360	360	495	427	250	45
300-360/20004	300	300	435	387	458	1100	660	610	243	800	450	860	510	240	1670	88	87,5	105	2094	1659	430	430	360	360	495	427	250	45
300-400/5504	350	300	410	425	439	1200	660	495	278	800	500	860	560	245	1720	90	87,5	95	1645	1235	490	430	420	360	392	418	250	53,5
300-400/7504	350	300	410	425	439	1200	660	555	278	800	500	860	560	245	1720	90	87,5	95	1748	1338	490	430	420	360	432	418	250	53,5
300-400/9004	350	300	410	425	439	1200	660	555	278	800	500	860	560	245	1720	90	87,5	95	1758	1348	490	430	420	360	432	418	250	53,5
300-400/11004	350	300	410	425	439	1200	660	610	278	800	500	860	560	245	1720	90	87,5	95	1767	1357	490	430	420	360	495	425	250	53,5
300-400/13204	350	300	410	425	439	1200	660	610	278	800	500	860	560	245	1720	90	87,5	95	1927	1517	490	430	420	360	495	425	250	53,5
300-400/16004	350	300	410	425	439	1200	660	610	278	800	500	860	560	245	1720	90	87,5	95	1927	1517	490	430	420	360	495	425	250	53,5
300-400/20004	350	300	410	425	439	1200	660	610	278	800	500	860	560	245	1720	90	87,5	95	2067	1657	490	430	420	360	495	425	250	53,5
300-400/25004	350	300	410	425	439	1200	800	610	278	800	500	860	560	245	1720	90	87,5	95	2156	1746	490	430	420	360	495	454	250	53,5
300-400/31504	350	300	410	425	439	1200	800	610	278	800	500	860	560	245	1720	90	87,5	95	2240	1830	490	430	420	360	495	454	250	53,5
300-500/1104	350	300	395	450	456	1235	660	610	278	800	500	860	560	255	1720	90	88	105	1747	1357	490	430	420	360	495	425	250	54
300-500/13204	350	300	395	450	456	1235	660	610	278	800	500	860	560	255	1720	90	88	105	1907	1517	490	430	420	360	495	425	250	54
300-500/16004	350	300	395	450	456	1235	660	610	278	800	500	860	560	255	1720	90	88	105	1912	1517	490	430	420	360	495	425	250	54
300-500/20004	350	300	395	450	456	1235	660	610	278	800	500	860	560	255	1720	90	88	105	2052	1657	490	430	420	360	495	425	250	54
300-500/25004	350	300	395	450	456	1235	800	710	278	800	500	860	560	255	1720	90	88	105	2141	1746	490	430	420	360	570	454	250	54
300-500/31504	350	300	395	450	456	1235	800	710	278	800	500	860	560	255	1720	90	88	105	2225	1830	490	430	420	360	570	454	250	54
350-340/2204	350	350	380	315	386	1075	450	363	278	750	450	810	510	235	1045	90	90	95	1469	1089	490	490	420	420	262	487	250	50
350-340/3004	350	350	380	315	386	1075	450	402	278	750	450	810	510	235	1045	90	90	95	1526	1146	490	490	420	420	300	487	250	50
350-340/3704	350	350	380	315	386	1075	450	442	278	750	450	810	510	235	1045	90	90	95	1690	1310	490	490	420	420	325	487	250	50
350-340/4504	350	350	380	315	386	1075	450	442	278	750	450	810	510	235	1045	90	90	95	1636	1256	490	490	420	420	325	496	250	50
350-340/5504	350	350	380	315	386	1075	660	495	278	750	450	810	510	235	1045	90	90	95	1750	1370	490	490	420	420	392	553	250	50
350-340/7504	350	350	380	315	386	1075	660	555	278	750	450	810	510	235	1045	90	90	95	1753	1373	490	490	420	420	432	553	250	50
350-340/9004	350	350	380	315	386	1075	660	555	278	750	450	810	510	235	1045	90	90	95	1863	1483	490	490	420	420	432	553	250	50
350-340/11004	350	350	380	315	386	1075	660	610	278	750	450	810	510	235	1045	90	90	95	1872	1492	490	490	420	420	495	560	250	50
350-340/13204	350	350	380	315	386	1075	660	610	278	750	450	810	510	235	1045	90	90	95	2032	1652	490	490	420	420	495	560	250	50

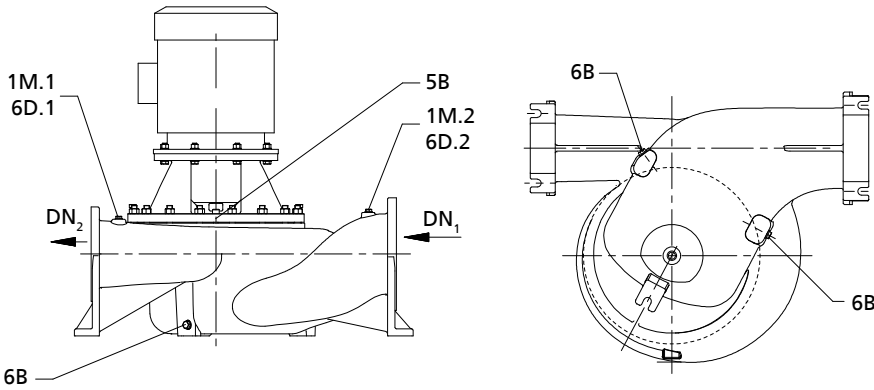
Connections

Fig. 2: Connections
Connection types

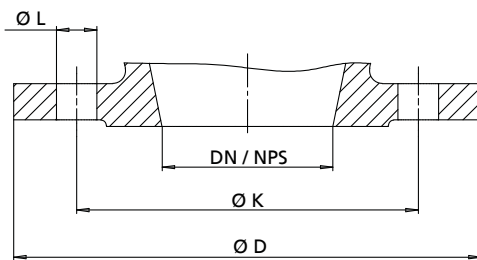
Connection	Description	Configuration	Position	Thread
1M.1/2	Pressure gauge connection	Drilled and closed, or pressure sensor for PumpMeter (if selected)	Suction flange and discharge flange	G1/2
5B	Vent connection for the mechanical seal chamber	Plugged with vent plug	Casing cover	G1/4
6B	Fluid drain	Drilled and closed	Casing	G3/4
6D.1/2	Fluid priming and venting	Drilled and closed	Casing	G1/2

Flange design

Fig. 3: Flange dimensions
Flange dimensions [mm]

DN/ NPS	Standard											
	EN 1092-2									ASME B 16.1		
	Material											
	S			G, M			G, M			G, M, S		
	PN 25			PN 16			PN 10			Class 125		
	Ø K	Ø D	Number of holes L	Ø K	Ø D	Number of holes L	Ø K	Ø D	Number of holes L	Ø K	Ø D	Number of holes L
150 / NPS6	250	300	8×Ø28	240	285	8×Ø23	240	285	8×Ø23	241,3	279,4	8×Ø22,4
200 / NPS8	310	360	12×Ø28	295	340	12×Ø23	295	340	8×Ø23	298,5	342,9	8×Ø22,4
250 / NPS10	370	425	12×Ø31	355	405	12×Ø28	350	395	12×Ø23	362	406,4	12×Ø25,4
300 / NPS12	430	485	16×Ø31	410	460	12×Ø28	400	445	12×Ø23	431,8	482,6	12×Ø25,4
350 / NPS14	490	555	16×Ø34	470	520	16×Ø28	460	505	16×Ø23	476,3	533,4	12×Ø28,4

Flange design by materials

Material variant	Standard	Nominal size	Pressure class
SN, SCN, SMN	EN 1092-2	DN 150 - DN 350	PN 25
	Drilled to ASME B16.1	DN 150 - DN 350	Class 125
GN, GCN, MN	Drilled to EN 1092-2	DN 150 - DN 350	PN 16 PN 10
	Drilled to ASME B16.1	DN 150 - DN 350	Class 125

General assembly drawings

General assembly drawing with list of components

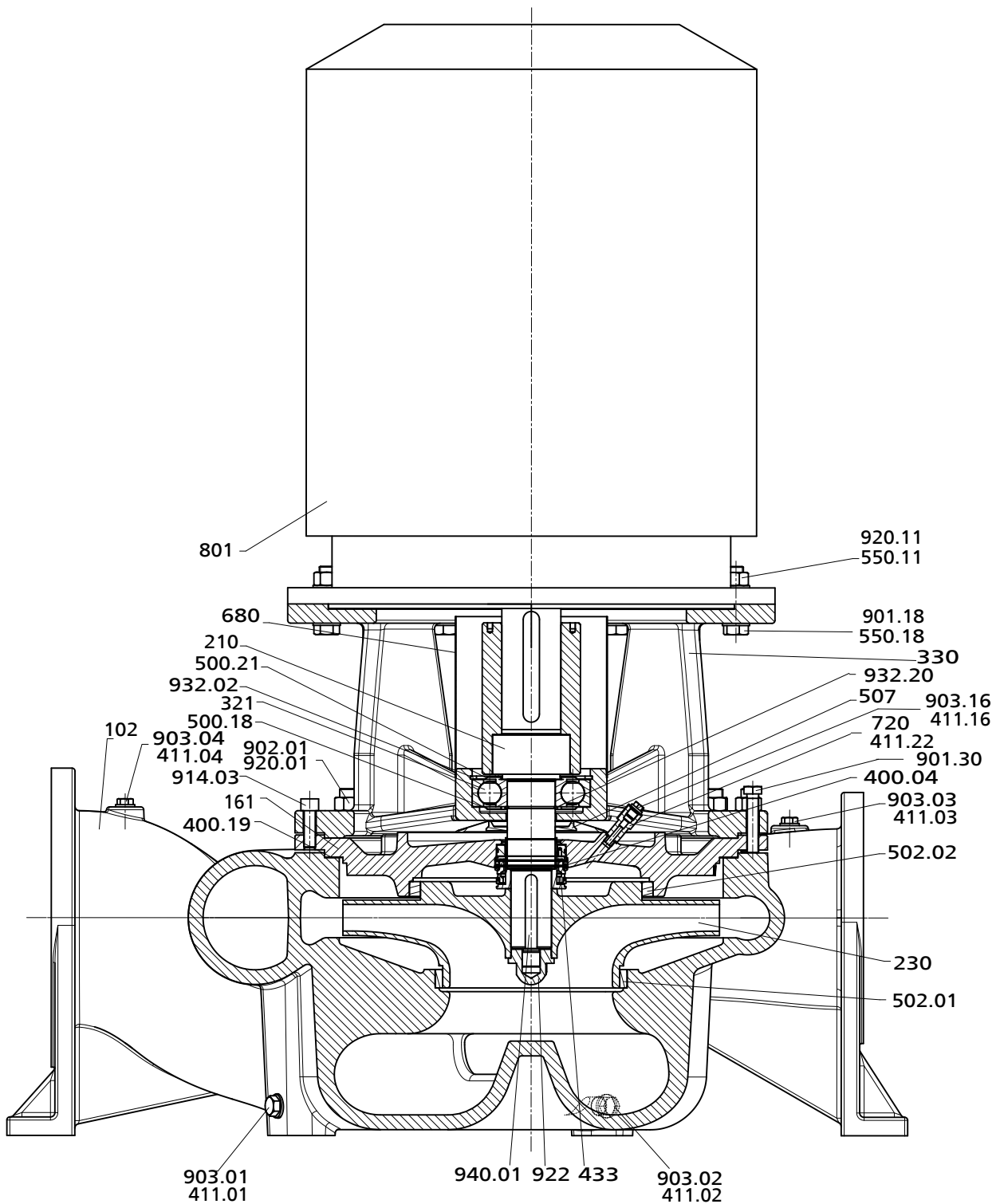

Fig. 4: General assembly drawing

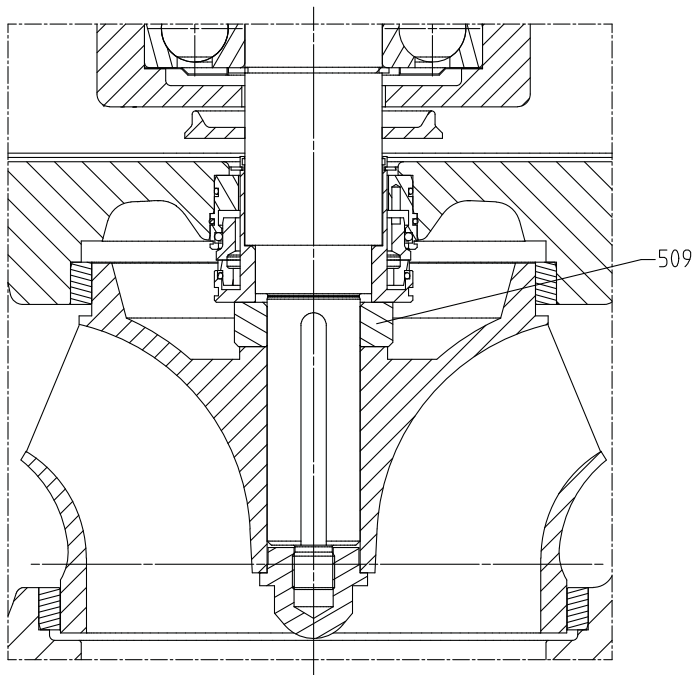

Fig. 5: Design with intermediate ring (for sizes 250-250, 250-300, 350-340 only)

List of components

Part No.	Description	Part No.	Description
102	Volute casing	550.11/.18	Disc
161	Casing cover	680	Guard
210	Shaft	720	Fitting
230	Impeller	801	Flanged motor
321	Radial ball bearing	901.18/.30	Hexagon head bolt
330	Bearing bracket	902.01	Stud
400.04/.19	Gasket	903.01/.02/.03/.04/.16	Screw plug
411.01/.02/.03/.04/.16/.22	Joint ring	914.03	Hexagon socket head cap screw
433	Mechanical seal	920.01/.11	Nut
500.18/.21	Ring	922	Impeller nut
502.01/.02	Casing wear ring	932.02/.20	Circlip
507	Thrower	940.01	Key
509 ¹²⁾	Intermediate ring		

12) On sizes 250-250, 250-300, 350-340 only:



KSB SE & Co. KGaA
Johann-Klein-Straße 9 • 67227 Frankenthal (Germany)
Tel. +49 6233 86-0
www.ksb.com